

TJ
7
M3
1.133



B 3 018 845

25 CENTS

HOBS AND GEAR HOBBING

A TREATISE ON THE DESIGN OF HOBS AND
AN INVESTIGATION INTO THE CONDITIONS
MET WITH IN GEAR HOBBING

BY JOHN EDGAR

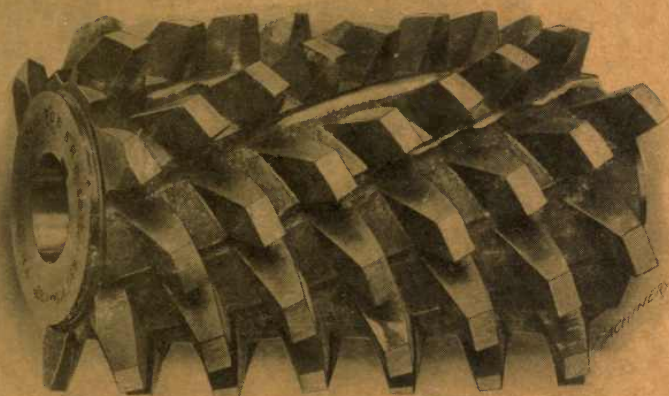

MACHINERY'S REFERENCE BOOK NO. 133
PUBLISHED BY MACHINERY, NEW YORK

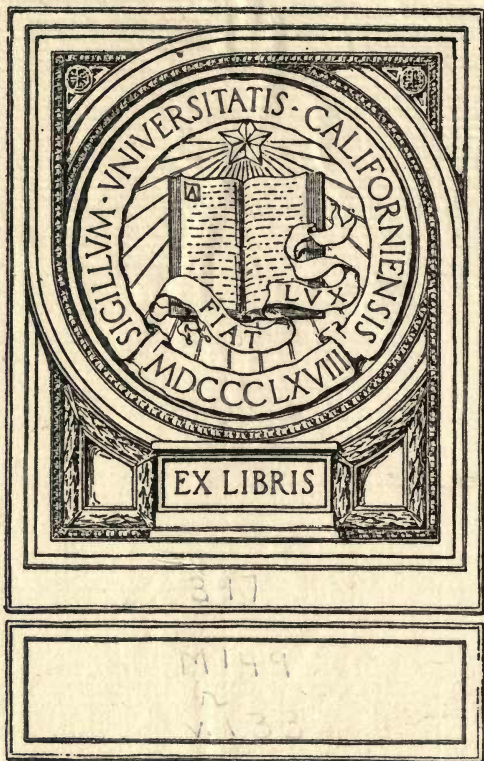

EX LIBRIS

317

M149
2
V.133



MACHINERY'S REFERENCE SERIES

EACH NUMBER IS ONE UNIT IN A COMPLETE LIBRARY OF
MACHINE DESIGN AND SHOP PRACTICE REVISED AND
REPUBLISHED FROM MACHINERY

NUMBER 133

HOBS AND GEAR HOBBING

By JOHN EDGAR

CONTENTS

Introduction: Principles of the Hobbing Process	-	3
Hobs for Spur and Spiral Gears	- - - -	5
Special Hob-tooth Shapes	- - - -	21
The Centering of the Hob in Gear Hobbing	- -	33
Hobbing vs. Milling of Gears	- - - -	41

UNIV. OF
CALIFORNIA

Other books in this series dealing with the subject of Gearing are as follows:

- No. 1—WORM GEARING
- No. 15—SPUR GEARING
- No. 20—SPIRAL GEARING
- No. 37—BEVEL GEARING

TJ7
M3
v. 133

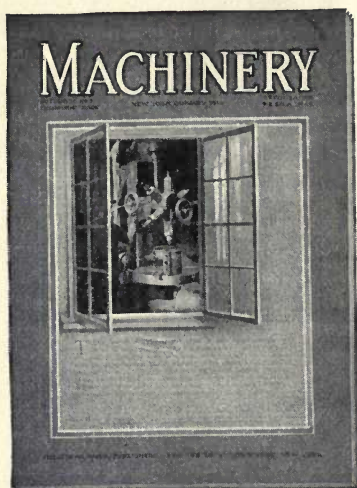

Small, illegible text or markings, possibly a library stamp or a small advertisement, located below the journal cover.

MACHINERY
The Leading
Mechanical Journal
MACHINE DESIGN
CONSTRUCTION
SHOP PRACTICE
THE INDUSTRIAL PRESS
140-148 Lafayette St.
New York City
51-52 Chancery Lane, London

INTRODUCTION

PRINCIPLE OF THE HOBGING PROCESS

The hobbing process for cutting the teeth in spur and spiral gears is beginning to be very widely used. The principle of this method is shown diagrammatically in the accompanying illustration. In the lower part of the illustration is shown an imaginary rack (in dotted lines); this rack is in mesh with the gear, the teeth of which are to be formed, and if the blank could be imagined as made of a plastic material, the rack, if moved along as indicated by the arrow, while the gear rotated to correspond, would form theoretically correct teeth in the gear blank. The teeth of this rack coincide with the outlines of the worm shown in full lines, this latter having been set at such an angle as to make the teeth on its front side parallel with the axis of the gear. In other words, it has been set at the angle of its helix, measured at the pitch line. This worm, when properly fluted, forms the hob for cutting the gear teeth. It will be seen that the teeth of the hob, when set in this position, correspond with the teeth of the rack. If, now, the hob and blank be rotated at the ratio required by the number of threads in the hob and the number of teeth in the gear, this movement will cause the teeth of the hob to travel lengthwise in exactly the same way as the teeth of the imaginary rack would travel, if in mesh with the gear, the teeth of which are to be cut. It will thus be seen that the hob fulfills the requirements necessary for molding the teeth of the gear to the proper form. In practice the hob is rotated in the required ratio with the work, and fed gradually through it from one side of the face to the other. When it has passed through once, the work is completed.

Of the great number of machines built during the past few years involving this principle, many are arranged for cutting spiral gears as well as spur gears. Of course, all of the machines capable of cutting spiral gears are capable of cutting spur gears also. The spiral gear-hobbing machine bears about the same relation to the plain spur gear-hobbing machine that the universal does to the plain milling machine. The added adjustments and mechanism required in each case tend to somewhat limit the capacity of the machine in taking heavy cuts, although they add to its usefulness by extending the range of work it is capable of performing.

Requirements of Gear Hobbing Machines

The requirements of the successful gear hobbing machine are:

- First. A frame and mechanism of great rigidity.
- Second. Durable and powerful driving mechanism.
- Third. Accurate indexing mechanism.

The first requirement is one of great importance, not only in its influence on the heaviness of the cut to be taken and the consequent

output of work, but on the matter of accuracy as well. The connection between the hob and the work, through the shafts and gearing, is liable to be so complicated that the irregular cutting action of the hob produces torsional deflections in the connecting parts, leading to serious displacement from the desired relation between the hob and the teeth being cut. This displacement from the desired position results in teeth of inaccurate shape, weak and noisy at high speeds.

In its effect on the output, rigidity is even more important in the

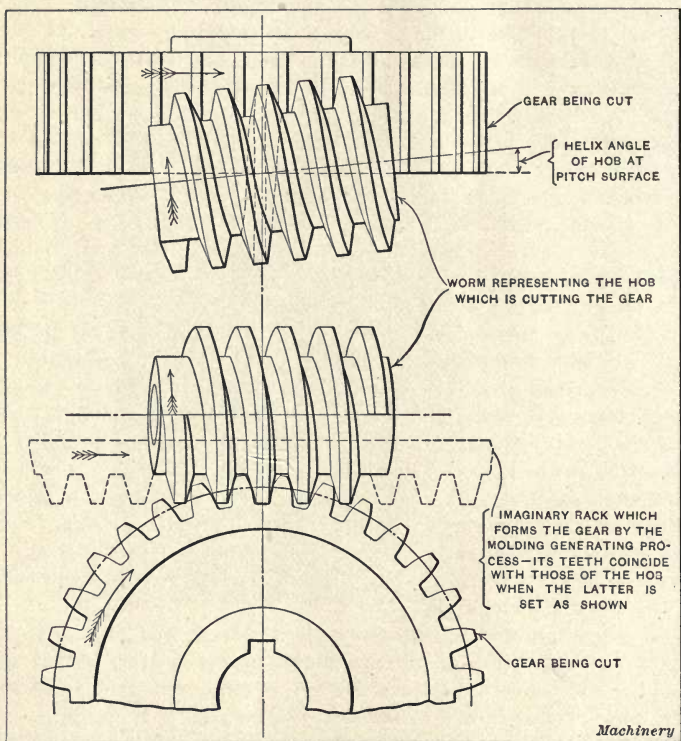

Diagram illustrating the Principle of the Hobbing Process of Forming Spur Gears

hobbing machine than in the orthodox automatic gear cutter. A heavier cut is taken, since a greater number of teeth are cutting on the work at once. The number of joints between the cutter and the work-supporting table and spindle must, therefore, be reduced to a minimum, and the matter of overhang both for the work and the cutter must be carefully looked out for. The reduction of overhang is hampered at the cutter head by the necessity for a strong drive and an angular adjustment. In the case of the work-supporting parts, it is difficult to bring the cutting point close to the bearing on account of the necessity for plenty of clearance below the work for the hob and its driving gear.

The matter of design of the driving mechanism for the hob and the work is a difficult one. Not only must it be rigid for the sake of accuracy, as previously explained, but careful attention must be given to durability as well. It requires great skill to design a durable mechanism for the purpose within the limitations imposed—in the cutter head by the necessity for reducing the overhang, and in the work table by the high speed required for cutting small gears.

Since the indexing wheel works constantly and under considerable load, both the wheel and worm must be built of such materials as will preserve their accuracy after long continued use. Particular attention should be given to the homogeneity of the material of the index worm-wheel, to make sure that it does not wear faster on one side than on the other.

The field of the hobbing process for cutting spur gears has, perhaps, not yet been definitely determined. In some work it appears to have great advantages over the usual type of automatic gear-cutting machine, while in other cases it seems to fall behind. It will doubtless require continued use, with a variety of work, and for a considerable length of time, to determine just what cases are best suited for the hobbing machine, and for the machine with the rotating disk cutter. It is quite probable that in the future neither of them will occupy the field to the exclusion of the other.

CHAPTER I

HOBS FOR SPUR AND SPIRAL GEARS

In explaining the methods used in the design of hobs for spur gears, it is best to assume a practical example. Suppose that the gears are to be cast iron, with 120 teeth, 16 diametral pitch and $\frac{5}{8}$ inch width of face. The pitch diameter, hence, is $7\frac{1}{2}$ inches. The hole in the hob for the spindle is to be $1\frac{1}{4}$ inch in diameter with a $\frac{1}{4}$ -square inch keyway, the hob to be run at high speed.

Form and Dimensions of Tooth

The first thing to be settled is the form and dimensions of the tooth or thread section of the hob. If the form is to be the standard shape for the involute system with a $14\frac{1}{2}$ -degree pressure angle, the dimensions of the hob tooth would be as shown in Fig. 1. A modification of this shape may in some cases be advisable, and will be referred to later in this chapter. The standard rack-tooth shape with straight sides, as shown in Fig. 1, however, is the easiest to produce, and it is entirely satisfactory, unless gears with a very small number of teeth are to be cut.

The circular pitch corresponding to 16 diametral pitch is 0.1963 inch, which is obtained by dividing 3.1416 by 16. The thickness of the tooth on the pitch line is one-half of the circular pitch, or 0.0982. The height of the tooth above the pitch line is equal to the reciprocal of the diametral pitch plus the clearance, which latter is equal to 0.1 of the thickness at the pitch line. Hence, the height of the tooth above the pitch line equals $0.0625 + 0.0098 = 0.0723$ inch. This distance equals the space in the gear below the pitch line.

The depth of the tooth of the hob below the pitch line is usually made greater than the distance from the pitch line to the top of the tooth. The extra depth should be equal to from one-half to one times the clearance. On small pitches, one times the clearance is not too great an allowance, and, therefore, the depth below the pitch line is made equal to $0.0723 + 0.0098 = 0.0821$, making the whole depth of

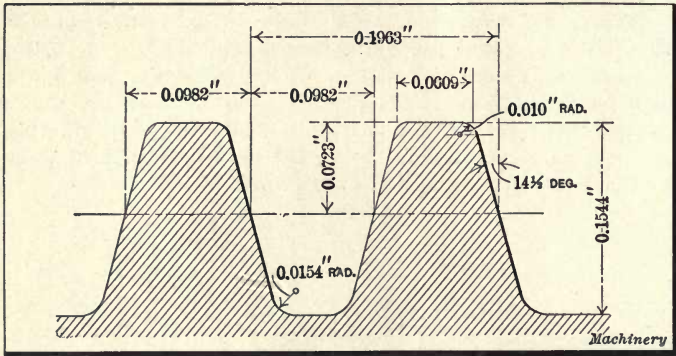

Fig. 1. Standard Hob Tooth Dimensions

tooth equal to 0.1544. The extra depth at the root of the thread is to allow for a larger radius at the root, so as to prevent cracking in hardening. The radius may then be made equal to two times the clearance, if desired. In the illustration, however, the radius is made equal to 0.1 of the whole depth of the tooth. The top corner of the tooth is rounded off with a corner tool to a radius about equal to the clearance, or say 0.010 inch. This corner is rounded to avoid unsightly steps in the gear tooth flank near the root. Having obtained the hob tooth dimensions, the principal dimensions of the hob may be worked out with relation to the relief, the diameter of the hole and the size of the keyway.

Relief of Hob Tooth

The proper relief for the tooth is a matter generally decided by experience. We may say that, in general, it should be great enough to give plenty of clearance on the side of the tooth, and on hobs of $14\frac{1}{2}$ -degree pressure angle the peripheral relief is, roughly speaking, about four times that on the side. For cutting cast iron with a hob of the pitch in question, a peripheral relief of 0.120 inch will give satisfactory results; for steel, this clearance should be somewhat in-

creased. The amount of relief depends, necessarily, also upon the diameter of the hob.

With a peripheral relief of 0.120 inch, the greatest depth of the tooth space in the hob must be $0.1544 + 0.120 = 0.2744$. The gash will be made with a cutter or tool with a 20-degree included angle, $3/32$ inch thick at the point, and so formed as to produce a gash with a half-circular section at the bottom. The depth of the gash should be $1/16$ inch deeper than the greatest depth of the tooth space, or about $11/32$ inch.

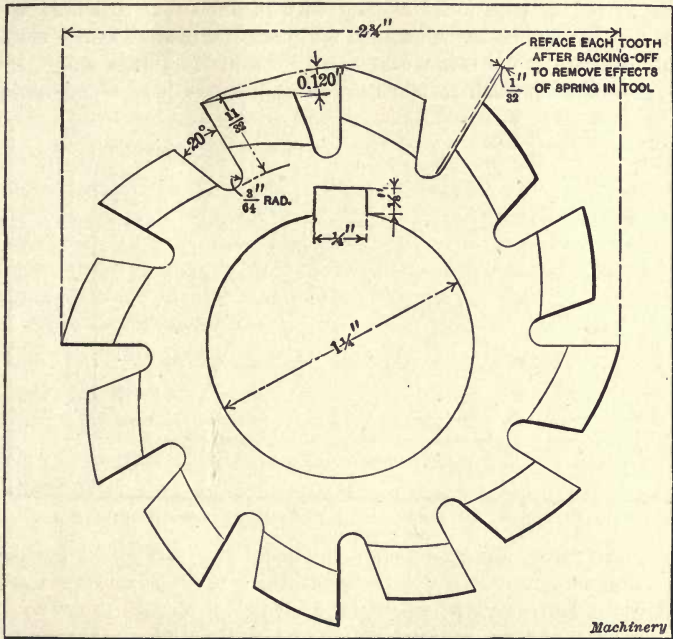

Fig. 2. Hob with Twelve Gashes or Flutes

Thickness of Metal at Keyway

The radius of the hob blank should be equal to $5/8 + 1/8 + 11/32 +$ the thickness of the stock between the keyway and the bottom of the flute. If we use a 3-inch bar, we can turn a hob blank $2\frac{3}{4}$ inches in diameter from this, which would allow sufficient stock to be turned from the outer portion of the bar to remove the decarbonized surface. If we make the blank $2\frac{3}{4}$ inches in diameter we have $9/32$ inch of stock over the keyway, which is sufficient.

Number of Flutes

The number of gashes or flutes depends on many factors. In Fig. 2 is shown an end view of a hob with twelve gashes. This number gives plenty of cutting teeth to form a smooth tooth surface on the gear without showing prominent tooth marks. A larger number of

gashes will not, in practice, give a better tooth form, but simply increases the liability to inaccuracies due to the forming process and to distortion in hardening. This number of gashes also leaves plenty of stock in the teeth, thus insuring a long life to the hob.

Straight or Spiral Flutes

The question whether the gashes should be parallel with the axis or normal to the thread helix is one that is not easily answered. It must be admitted that when the angle of the thread is great, the cutting action at both sides of the tooth is not equal in a hob with a straight gash; but in cases of hobs for fine pitch gears, where the hobs are of comparatively large diameter, thus producing a small thread angle, the parallel gash is more practical because it is much easier to

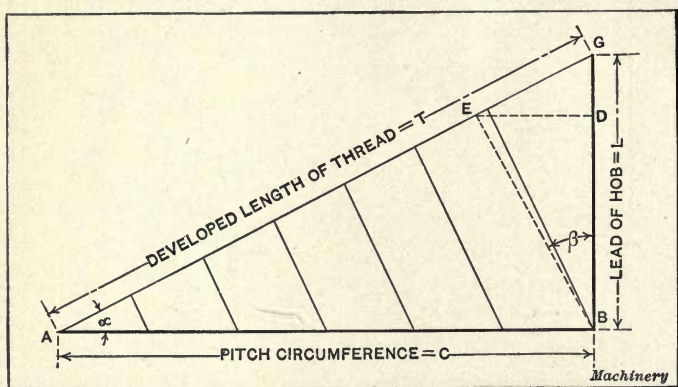

Fig. 3. Diagram for Derivation of Formula for Spirally-fluted Hobs

sharpen the hobs, and the long lead necessary for spiral gashes, in such cases, is not easily obtained with the regular milling machine equipment. However, when it is desired to obtain the very best results from hobbing, especially in cutting steel, the gash should be spiral in all cases when the thread angle is over $2\frac{1}{2}$ or 3 degrees. In our case the thread angle figured at the pitch diameter of the blank is equal to 1 degree 22 minutes; hence, straight flutes are not objectionable.

Spiral-fluted Hob Angles

As mentioned, it is desirable that hobs should be fluted at right angles to the direction of the thread. Sometimes, however, it is necessary to modify this requirement to a slight degree, because the hobs cannot be relieved unless the number of teeth in one revolution, along the thread helix, is such that the relieving attachment can be properly geared to suit it. In the following (from an article by G. H. Gardner in MACHINERY) it is proposed to show how an angle of flute can be selected that will make the flute come approximately at right angles to the thread, and at the same time the angle is so selected as to meet the requirements of the relieving attachment.

Let C = pitch circumference;

T = developed length of thread in one turn;

N = number of teeth in one turn along thread helix;

F = number of flutes;

α = angle of thread helix.

Then (see Fig. 3):

$C \div F$ = length of each small division on pitch circumference.

$(C \div F) \times \cos \alpha$ = length of division on developed thread.

$C \div \cos \alpha = T$.

$$\text{Hence } \frac{T}{(C \div F) \cos \alpha} = N = \frac{F}{\cos^2 \alpha}$$

Now, if $\alpha = 30$ degrees, $N = 1\frac{1}{3} F$;

$\alpha = 45$ degrees, $N = 2 F$;

$\alpha = 60$ degrees, $N = 4 F$.

In most cases, however, such simple relations are not obtained. Suppose for example that $F = 7$, and $\alpha = 35$ degrees. Then $N = 10.432$, and no gears could be selected that would relieve this hob. By a very slight change in the spiral angle of the flute, however, we can change N to 10 or $10\frac{1}{2}$; in either case we can find suitable gears for the relieving attachment.

The rule for finding the modified spiral lead of the flute is:

Multiply the lead of the hob by F , and divide the product by the difference between the desired value of N and F .

Hence, the lead of flute required to make $N = 10$ is:

Lead of hob $\times (7 \div 3)$.

To make $N = 10\frac{1}{2}$, we have:

Lead of flute = lead of hob $\times (7 \div 3.5)$.

From this the angle of the flute can easily be found.

That the rule given is correct will be understood from the following consideration. Change the angle of the flute helix β so that AG contains the required number of parts N desired. Then EG contains $N - F$ parts; but $\cot \beta = BD \div ED$, and by the law of similar triangles:

$$BD = \frac{F}{N} \times BG, \text{ and } ED = \frac{N - F}{N} C$$

The lead of the spiral of the flute, however, is $C \times \cot \beta$.

Hence, the required lead of spiral of the flute:

$$C \times \cot \beta = \frac{F}{N - F} L$$

This simple formula makes it possible always to flute hobs so that they can be conveniently relieved, and at the same time have the flutes at approximately right angles to the thread.

Graphical Method

The angle of the flutes, determined so as to avoid difficulties in relieving, may be found graphically as follows: First, lay off a base line AA , Fig. 4, of any convenient length. Then erect the perpendicular AC making it equal to the developed length of the pitch circumference of the hob. From C draw line CD parallel to the base line AA and of a length equal to the lead of the hob. Now drawn diagonal AD which represents the thread. Divide AC into as many equal parts as there are flutes in the hob, as a , b and c . From C and a draw lines through and at right angles to the diagonal AD , as CE and aF . Then length EF equals the pitch of the flutes on the thread when the gash-

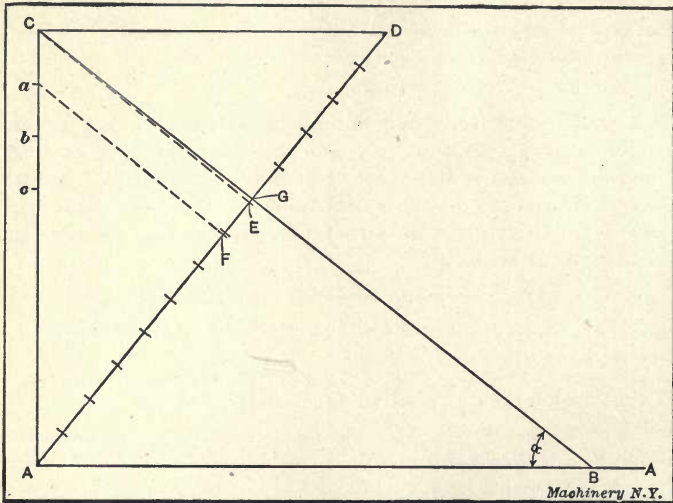

Fig. 4. Graphical Method of Finding Gashing Angle and Number of Flutes for which Backing-off Attachment should be set for Spiral-fluted Hobs

ing is at right angles to the thread. To proceed, divide AD into a certain number of equal parts, the length of these parts to be as near to the length EF as possible. Step off these divisions on AD , and through the division nearest to E , as at G , draw a line from C to the base line intersecting the base line at B . This line CB represents the gash, line AB the lead of the gash, and the number of divisions in the line AD equals the number of flutes to one revolution of the hob, for which we must gear the machine.

To get the exact length of AB , divide the number of divisions in AG by the number of divisions in GD and multiply the result by the length of the line CD or the lead of the hob. The angle a which is the angle for gashing can be found by scaling the diagram. For example, let the hob be 2 inches pitch diameter, lead 5 inches, and number of flutes 8.

We first draw base line AA , and the line AC 6.28 inches long which is the pitch circumference. Now draw CD 5 inches long, and then

draw line AD . We now divide AC into eight equal parts and draw lines from C and a through and at right angles to AD , intersecting AD , at E and F . Setting the dividers to length EF we step off line AD and find that this length EF will go into AD a little over thirteen times; so we divide this line AD into thirteen equal parts. It is now necessary to gear the machine for thirteen flutes to one revolution of the hob.

The division nearest to E is G , so by drawing a line from C through G we intersect the base line at B . In the line GD there are five divisions, and in the line AG there are eight divisions. The lead of the hob is five inches, so that the length of the lead for

$$\text{the gash or } AB \text{ is } \frac{8}{5} \times 5 = 8$$

inches. By measuring on the diagram with a scale we find the gashing angle is $38\frac{1}{4}$ degrees. Therefore, we will gear the machine used in backing off the hob for 13 flutes to one revolution, and we will gear the milling machine to cut a lead of 8 inches, and at a gashing angle of $38\frac{1}{4}$ degrees.

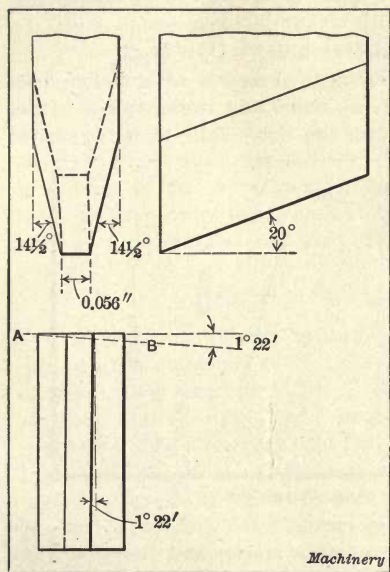

Fig. 5. Threading Tool for Hob

In the present case they do not differ appreciably and may be considered as equal. In cases where the difference is over 0.0005, the true linear pitch should be used.

The change-gears for the lathe may be figured by the formula:

$$\frac{\text{Gear on lead-screw} \times \text{lead of lead-screw}}{\text{Gear on stud} \times \text{linear pitch of hob}} = 1$$

On a lathe with a lead-screw of six threads per inch, or a lead of $\frac{1}{6}$ or 0.1667 inch, the gears that would give accurate enough results for the present hob would be 28 teeth on the lead-screw, and 33 teeth on the stud.

Thread Relieving Tool

In Fig. 5 is shown the hob thread relieving tool. The front of the tool is relieved with a 20-degree rake for clearance. The sides are ground straight at a $14\frac{1}{2}$ -degree angle to form the sides of the thread,

and are at an angle of 1 degree 22 minutes with the vertical to clear the sides of the thread. A tool make like this can be sharpened by grinding across the top without losing its size or form. If the gashes were made on the spiral, the top of the tool should be ground to the angle of the thread, as shown by the dotted line *AB*. In cases where the angle of the thread is considerable, the angle of the sides of the tool must be corrected to give the proper shape to the hob tooth. (See *MACHINERY*, May, 1905, or *MACHINERY'S* Reference Book No. 32, "Formula for Planing Thread Tools.") The point of the tool should be stoned to give the proper radius to the fillet in the bottom of the hob tooth space.

Heat-treatment of Hob

The best practice in making the hob is to anneal it after it has been bored, turned, gashed and threaded, the annealing taking place before relieving the teeth. Before hardening, the hob ought to be re-gashed

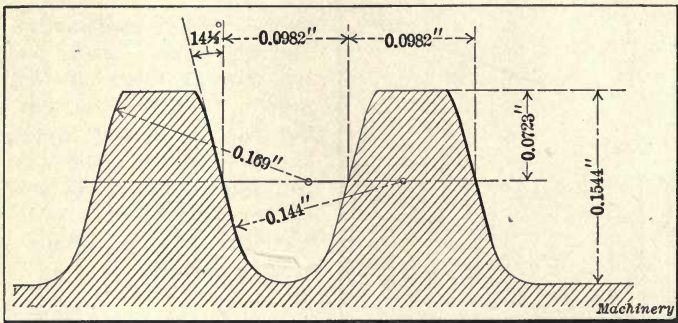

Fig. 6. Special Hob Tooth Dimensions

or milled in the groove, removing about 1/32 inch of stock from the front side of the tooth to eliminate chatter marks and the effect due to the spring in the tool, which always leaves the front edge of the teeth without relief. In hardening, do not attempt to get the hob too hard, as the required high heat and quick cooling would distort the teeth badly.

Modified Tooth Shape in Hob

In case the 120-tooth gear is to run with a pinion of a small number of teeth and is the driver, as in small hand grinders where gears of this size are often used, it would be advisable to make the tooth shape as shown in Fig. 6. This shape will obviate undercutting in the pinion and relieve the points of the teeth in the gear so as to obtain a free-running combination. This shape is more difficult to produce and requires more care in forming. If the hob is made of high-speed steel, it should run at about 115 revolutions per minute for cutting an ordinary grade of cast iron with a feed of 1/16 inch per revolution of the blank. The feed may be increased considerably if the gear blank is well supported at the rim. The best combination of speeds and feeds in each case can be found only after considerable experimenting.

Defects in Hobs

The success of the hobbing process for cutting teeth in spur and spiral gears depends, as stated, more upon the hob than upon the machine, and at the present stage of development the hob is the limiting factor in the quality of the product. It is well known that hobs at the present time are far from being standardized, and that the product will not be interchangeable if the hob of one maker is substituted for that of another; in fact, the using of two hobs from the same maker successively will sometimes result in the production of gears which will not interchange or run smoothly. This is not a fault of the hobbing process, but is due to the fact that the cutter manufacturers have not given the question of hobs the study it requires. This is also the reason why there are so many complaints about the hobbing machine. Nevertheless, with the proper hob the hobbing machine is the quickest method of machining gears that has ever been devised. Its advantage lies in the continuous action and in the simplicity of its mechanism. There is no machine for producing the teeth of spur gears that can be constructed with a simpler mechanism, and even machines using rotary cutters are more complicated if automatic.

Hobs with Few Teeth give Best Results

The ideal form of hob, theoretically speaking, would be one that had an infinite number of cutting teeth. In practice, however, a seemingly contradictory result is obtained, as hobs with comparatively few teeth give the best results. The reasons for this are due to purely practical considerations. Strictly speaking, a theoretical tooth curve is no more possible when the tooth is produced by the hobbing process than when produced by the shaper or planer type of generator, but for all practical purposes, the curve generated under proper working conditions is so nearly correct as to be classed as a theoretical curve. If this result is not often met with under ordinary working conditions, it is due to the fact that the hob is not as good as present practice is able to make it.

Causes of Defects in Hobbed Gears

In order to obtain, as far as is theoretically possible, a proper curve and not a series of flat surfaces, the teeth of the hob must follow in a true helical path. In ninety-nine cases out of one hundred the hob is at fault when a series of flats is obtained instead of a smooth curved tooth face. It is the deviation of the teeth of the hob from the helical path that is at the root of most hobbing machine troubles. There are several causes for the teeth being out of the helical path: The trouble may have originated in the relieving or forming of the teeth; the machine on which this work has been done may have been too light in construction, so that the tool has not been held properly to its work, and has sprung to one side or another causing thick and thin teeth in the hob; a hard spot may have been encountered causing the tool to spring; the gashes may not have been properly

spaced, or there may have been an error in the gears on the relieving lathe influencing the form; the hob may also have been distorted in hardening; it may have been improperly handled in the fire or bath, or it may have been so proportioned that it could not heat or cool uniformly; the grinding after hardening may be at fault; the hole may not have been ground concentric with the form, thus causing the teeth on one side of the hob to cut deeper than on the other. Any one or a combination of several of these conditions may have thrown the teeth out of the true helical path.

Fig. 7 illustrates the difficulty of thick and thin teeth. The tooth *A* is too thick and *B* is too thin, the threading tool having sprung over from *A* and gouged into *B*. Fig. 7 also shows a developed layout of the hob. At *C* is shown the effect that thick and thin teeth may have on

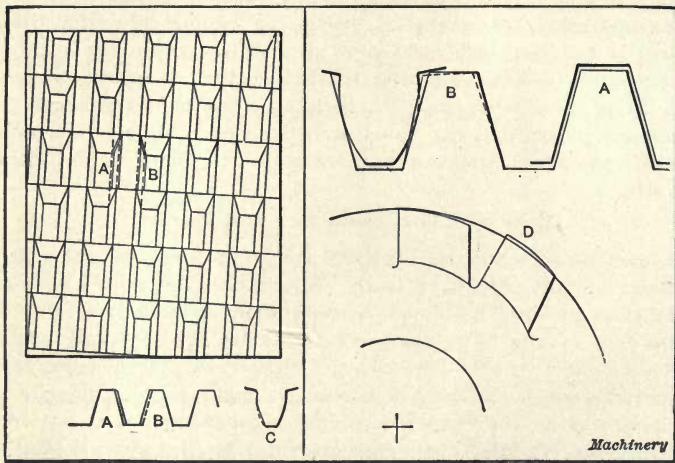

Figs. 7 and 8. Distortion of Hob Teeth and its Effect

the tooth being cut in the gear—that of producing a flat on the tooth. This flat may appear on either side of the tooth and at almost any point from the root to the top, depending upon whether the particular hob tooth happens to come central with the gear or not. If it does come central or nearly so, it will cause the hob to cut thin teeth in the blank. The only practical method to make a hob of this kind fit for use is to have it re-formed.

In Fig. 8 is shown at *A* the result of unequal spacing of the teeth around the blank. Owing to the nature of the relief, the unequal spacing will cause the top of the teeth to be at different distances from the axis of the hob. This would produce a series of flats on the gear tooth. One result of distortion in hardening is shown at *B*, Fig. 8, where the tooth is canted over to one side so that one corner is out of the helical path. This defect also produces a flat and shows a peculiar under-cutting which at first is difficult to account for. Sometimes a tooth will distort under the effects of the fire in the manner indicated at *D*, Fig. 8.

These defects may be avoided by proper care and by having the steel in good condition before forming. The blank should be roughed out, bored, threaded, gashed and then annealed before finish-forming and hardening. The annealing relieves the stresses in the steel due to the rolling process.

The proportions of the hob have a direct effect on distortion in hardening. This is especially noticeable in hobs of large diameter for fine pitches. Fig. 9 shows the results obtained in hardening a 4-inch hob, 10 pitch, with $1\frac{1}{4}$ -inch hole. There is a bulging or crowning of the teeth at A. This is accounted for by the fact that the mass of metal at B does not cool as quickly as that at the ends. Consequently, when the hob is quenched, the ends and outer shell cool most quickly and become set, preventing the mass at B from contracting as it would

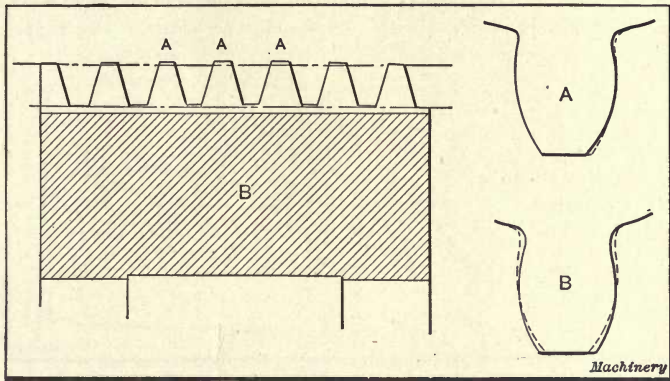

Figs. 9 and 10. Distortion of Hobs and Result on the Shape of the Teeth

if it could come in direct contact with the cold bath and cool off as quickly as the rest of the metal. The effect of this distortion on the shape of the gear teeth is indicated in Fig. 10, where the tooth A is unsymmetrical in shape due to the fact that the teeth near the center of the hob cut deeper into the blank, under-cutting the tooth on one side and thinning the point. This effect is produced when the gear is centered near the ends of the hob. If the gear is centered midway of the length of the hob, the tooth shape produced is as shown at B, Fig. 10. This tooth is thick at the point and under-cut at the root.

A hob in this condition makes it impossible to obtain quiet running gears. In this case, it would be useless to anneal and re-form the hob, as the same results would be certain to be met with again, on account of the proportions of the hob. Hence, defects of this kind are practically impossible to correct, and the hob should either be entirely re-made or discarded.

Figs. 11 and 12 show in an exaggerated manner two common defects due to poor workmanship. In Fig. 11 the hole is ground out of true with the outside of the tooth form. The hole may run either parallel with the true axis of the hob, or it may run at an angle to it, as seen in Fig. 12. The effect of the first condition is to produce a

tooth shaped like that shown by the full lines at *B* in Fig. 10, and the effect of that in Fig. 12 is about the same, except that the hob will cut thin teeth when cutting to full depth. Gears cut by either hob will lock with meshing gears, and instead of smooth rolling, the action will be jerky and intermittent.

Gashes which originally were equally spaced may have become unequally spaced by having more ground off the face of some teeth than of others. The greater the amount of relief, the more particular one must be in having the gashes equally spaced.

Grinding to Correct Hob Defects

These various faults may be corrected to a greater or less extent in the following manner: Place the hob on a true arbor and grind the outside as a shaft would be ground; touch all of the teeth just enough so that the faintest marks of the wheel can be seen on the tops. The

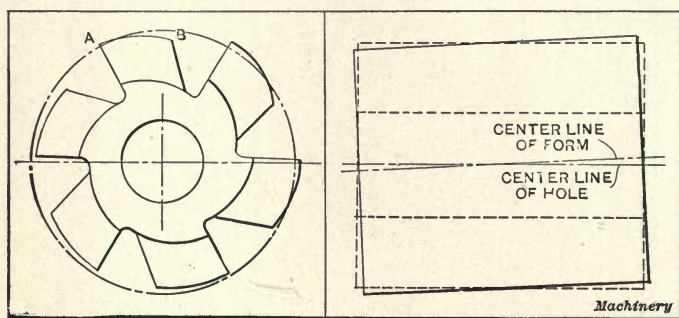

Figs. 11 and 12. Hobs with the Center Hole out of True with the Outside of the Tooth Form

teeth that are protruding and would cause trouble will, of course, show a wide ground land, while on those that are low, the land will be hardly visible. Now grind the face of each tooth back until the land on each is equal. This will bring all the teeth to the same height and the form will run true with the hole. To keep the hob in condition so that it will not be spoiled at the first re-sharpening, grind the backs of the teeth, using the face as a finger-guide, the same as when sharpening milling cutters, so as to remove enough from the back of each tooth to make the distance *AB*, Fig. 11, the same on all the teeth. Then, when sharpening the teeth in the future, use the back of the tooth as a finger-guide. If care is taken, the hob will then cut good gears as long as it lasts. It is poor practice to use the index head when sharpening hobs, because the form is never absolutely true with the hole, and unless the hob has been prepared as just described, there is no reliable way to sharpen it. If the hob, after having been prepared as described, is sharpened on centers by means of indexing, it will be brought back to the original condition.

The defect shown in Fig. 12 is corrected in the same manner. The gash when so ground will not be parallel with the axis in a straight-fluted hob, nor will it be at an exact right angle with the thread helix

in a spiral-fluted hob, because the teeth at the right-hand end are high while those at the left-hand end are low, and the amount that must be ground off the faces of the hob teeth will be greater at one end than at the other. The angle will be slight, however, and of no consequence.

Shape of Hob Teeth

The first thing that is questioned when a hob does not produce smooth running gears is the shape of the hob tooth. The poor bearing obtained when rolling two gears together would, in many cases, seem to indicate that the hob tooth was of improper shape, but in nearly

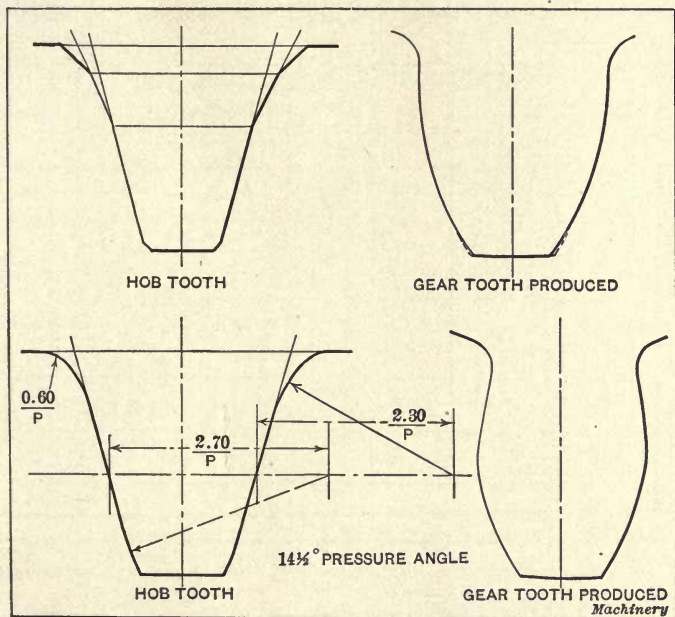

Fig. 13. Forms of Hob Teeth and Gear Teeth Produced

every case the trouble is the result of one or more of the defects already pointed out.

Theoretically, the shape of the hob tooth should be that of a rack tooth with perfectly straight sides. This shape will cut good gears from thirty teeth and up, in the $14\frac{1}{2}$ -degree involute system, but gears under thirty teeth will have a reduced bearing surface as a result of under-cutting near the base circle, which increases as the number of teeth grows smaller. The shape produced by such a hob, if mechanically perfect, would be a correct involute, and the gears should interchange without difficulty. In order that the beginning of contact, however, may take place without jar, the points of the teeth should be relieved or thinned, so that the contact takes place gradually, instead of with full pressure. This is accomplished by making the hob tooth thicker at the root, starting at a point considerably

below the pitch line. This is illustrated in the upper portion of Fig. 13, which shows the standard shape adopted by the Barber-Colman Co. The shape of the tooth produced is also shown. The full lines show the shape generated, and the dotted, the lines of the true involute. The amount removed from the points is greater on large gears and less on small pinions, where the length of contact is none too great even with a full shaped tooth, and where any great reduction must be avoided. This shape of hob tooth does not, however, reduce under-cutting on small pinions. The fact that hobbled gears have under-cut teeth in small pinions, while those cut with rotary cutters have radial flanks with the curve above the pitch line corrected to mesh with

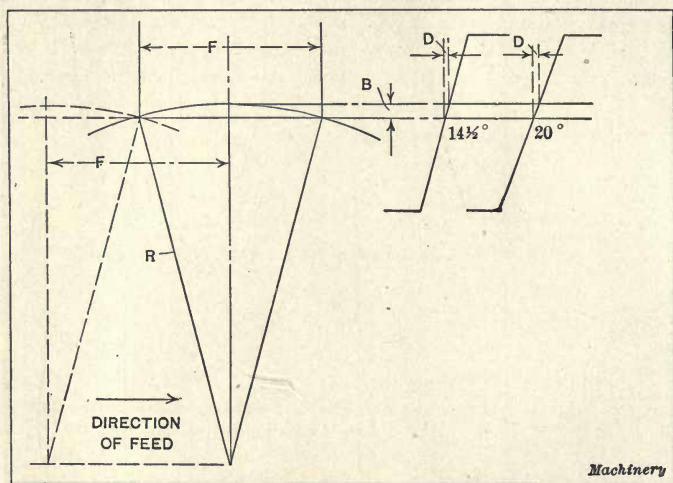

Fig. 14. Illustrating Effect of Feed in Hobbing

them is the reason why hobbled gears and those cut with rotary cutters will not interchange.

In the lower part of Fig. 13 is shown a hob tooth shape which will produce teeth in pinions without under-cutting, the teeth, instead, having a modified radial flank. The radii of the correction curves are such that the gear tooth will be slightly thin at the point to allow an easy approach of contact. The shape shown is approximately that which will be produced on hobs the teeth of which are generated from the shape of a gear tooth cut with a rotary cutter, which it is desired to reproduce.

Diameters of Hobs

The diameters of hobs is a subject which has been much discussed. Many favor large hobs because the larger the hob the greater the number of teeth obtainable. This, however, has already been shown to be a fault, because the greater is the possible chance of some of the teeth being distorted. For the same feed, the output of a small hob is greater, because of being inversely proportional to the diameter. The number of teeth cut is directly proportional to the number of

revolutions per minute of the hob. The number of revolutions depends on the surface speed of the hob; therefore, the small hob will produce more gears at a given surface speed.

It may be argued that, on account of the large diameter, the large hob can be given a greater feed per revolution of the blank than the smaller hob, for a given quality of tooth surface. This argument is analyzed in Fig. 14. Let R be the radius of the hob and F the feed of the hob per revolution of the blank. Then B may be called the rise of feed arc.

Since the surface of the tooth is produced by the side, the actual depth of the feed marks is D , which depends on the angle of the side

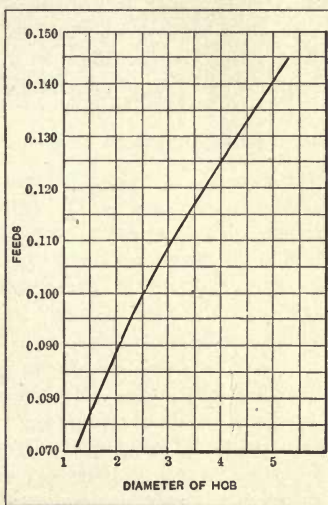

Fig. 15. Diagram showing Comparative Feeds for Hobs of Various Diameters

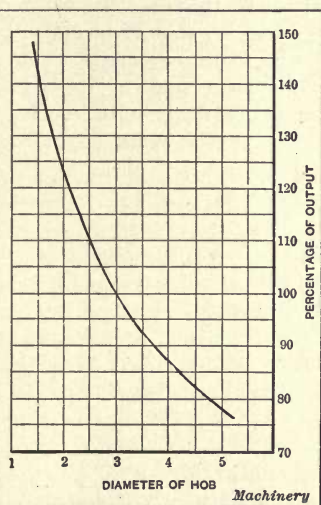

Fig. 16. Diagram showing Comparative Output of Hobs of Various Diameters based on 3-inch Hob

of the tooth, the depth being greater for a 20-degree tooth than it would be for a 14½-degree tooth for the same amount of feed. The relations between F , R , and B may be expressed as follows:

$$F = 2 \sqrt{2RB - B^2}$$

Since B is a very small fractional quantity, B^2 would be much smaller and can, therefore, be disregarded, giving the very simple approximate formula $F = 2 \sqrt{2RB}$. A rise of 0.001 inch would mean a depth D of about 0.00025 inch on a 14½-degree tooth. The allowable feed is 0.126 inch for a 4-inch hob and 0.108 inch for a 3-inch hob for a 0.001 inch rise. The curve in Fig. 15 shows the feeds for this rise for various hob diameters. Fig. 16 shows a curve based on a 3-inch hob that shows the comparative output for an equal rise. This curve shows that the smaller hob is superior in matter of production.

The larger hobs are also more liable to distortion in hardening

and they do not clear themselves as well as the smaller ones when cutting; consequently, they need a greater amount of relief. Large hobs also require a greater over-run of feed at the start of the cut. When cutting spiral gears of large angles this greatly reduces the output, as the greater amount of feed required before the hob enters to full depth in the gear is a pure waste.

The question of whether the gashes or flutes should be parallel with the axis or at right angles to the thread helix has two sides. From a practical point of view, it appears to make very little difference in the results obtained in hobs of small pitch and angle of thread. In hobs of coarse pitch, however, the gashes should undoubtedly be normal to the thread. The effect of the straight gash is noticed when cutting steel, in that it is difficult to obtain a smooth surface on one side of the tooth, especially when cutting gears coarser than 10 pitch. What has been said in the foregoing, however, applies equally to straight and spirally fluted hobs.

CHAPTER II

SPECIAL HOB-TOOTH SHAPES

There is always an objection to changing existing methods in shop practice when the change necessitates discarding established standards and valuable tools and fixtures. Whether such a change will be profitable or not is a question that requires a close study of the conditions in each case. When the change means an improvement in the quality of the product, the cost of the tools and fixtures should, of course, be a secondary consideration. When the question is mainly one of quantity, the problem must be solved on a cost basis only.

Interchangeability of Hobbed and Milled Gears

Another factor to be considered, however, is that of interchangeability. This is a most important item in the case of a product in connection with which renewals are constantly being made. Many improvements in design and in methods of manufacture are sacrificed in deference to the demands for interchangeability. In the case of gears, interchangeability is supposed to be rigidly adhered to, but while we have a standard which is supposed to produce interchangeable gears, we have so many variations of the standard, due to the secret forms established by different manufacturers of cutters, that it is necessary in many cases to adhere to one make of tools if interchangeability is to be maintained in any degree. Many manufacturers have installed the hobbing machine in the desire to reduce the cost of gearing, only to encounter the non-interchangeability of the product of the hobbing machine with the milled tooth gear; this has been the cause of turning many against the hobbing machine, through no fault of the process itself.

Variations from the True Involute Tooth Shape

The form of the standard tooth, as adopted by the cutter manufacturers, is not the true involute, but an improvised form built around the involute as a basis. The deviation from the involute is necessary for several reasons:

1. The inability of the formed milling cutter to mill an undercut tooth.
2. The necessary alteration in the form of the point of the mating tooth caused by the fullness of the milled tooth below the pitch line.
3. The desire to make the contact of the approach as gradual as possible by a slight easing off of the form at the point of the tooth; this provides against the slight variation in the form of the tooth due to irregularities in the division of the space and to the elasticity of the material.

4. The interference in gears with thirty-two teeth or less when in mesh with those of a greater number of teeth. As the $14\frac{1}{2}$ degree formed gear-cutters are based on the twelve-tooth pinion with radial flanks, a rack tooth to mesh with this radial flank tooth can be made with the straight sides extending only to a point 0.376 inch outward from the pitch line in a rack of one diametral pitch. The remainder of the tooth must be eased off from this point outward, sufficiently to clear the radial flank of the pinion tooth. This rounding off of the rack tooth may be made by using the cycloidal curve from the interference point, with a rolling circle of a diameter equal to that of the twelve-tooth pinion. A circular arc tangent to the tooth side, drawn from a center on the pitch line at the point of intersection of the normal to the tooth side at the point of interference, will be a near approximation to the cycloidal curve.

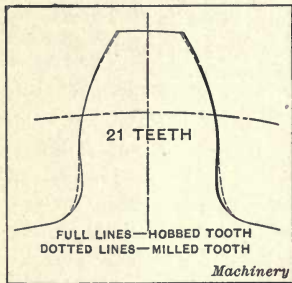

Fig. 1. Comparison between Hobbed and Milled Gear Teeth

The hobs used extensively today are not made to produce teeth in any near approximation to the shape produced by the milling cutter. The only correction that is made, in many cases, is to make the teeth of the hob a trifle fuller at the base or root to ease the approach; even this is done only in a few instances. The difference between the hobbled tooth and that produced by milling is seen in Fig. 1.

The hobbled tooth is shown in full; this shape was traced from an actual hobbled tooth, photographed and enlarged. The gear had twenty-one teeth. The hob used was corrected for the "thinning" of the tooth at the point, but in a gear of this diameter the effect would not show to any great extent. The dotted lines are drawn from actual milled tooth curves and show the difference between the two forms of teeth. Attention is called to the fullness of the milled tooth at the root, and the thinning of the tooth at the point. The difference would be greater in the case of a twelve-tooth pinion.

The filling-in of the flank of the tooth is not done to any rule based on a proportion to the number of teeth in the gear. The curve selected is made to fill the space at the root to just clear the corrected rack tooth. Neither is the thinning of the tooth at the point proportional to the diameter in the sense that the curve of the hobbled tooth is. Each form of the cutter system is made and varied to the extent necessary for smooth action, and the curves of the entire system cannot be produced by the hobbing process with a single hob. To accurately reproduce the form of the milled tooth, a special hob would be necessary for each number of teeth. However, a close approximation may be obtained, within a narrow range of teeth, with a hob generated from a milled tooth. This is being done in the automobile industry with good results. The necessity for interchangeability makes the duplication of the milled tooth imperative when the originals were made with the formed cutter, and the introduction of

the hobbing machine, in such cases, depends on the successful duplication of these forms. It is no exceptional thing to see the hobbing process used in conjunction with the automatic gear-cutter in the production of interchangeable transmission and timing gears. The shapes produced by the standard sets of cutters, from a rack to a twelve-tooth pinion, cannot, however, be generated by a single hob, because the shapes are only an approximation of the correct curve. The gears mentioned above as being successfully hobbled are, therefore, when milled, cut with special cutters for each number of teeth, as in this way only can a curve of correct shape be obtained.

As stated above, most hobs are of the straight-sided shape, and the tooth hobbled is of pure involute form. In gears of less than thirty-two teeth, the flank is undercut to a considerable extent. This undercutting does not involve any incorrect action in the rolling of the gears, but in the case of the twelve-tooth gear, for example, the

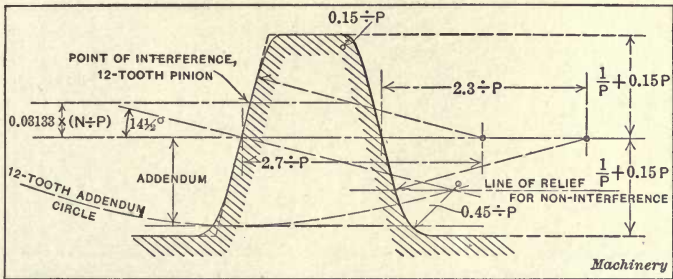

Fig. 2. Hob Tooth designed to generate the Approximate Shape of a 14½-degree Involute Milled Tooth

involute is cut away at the base line close to the pitch line, giving but a line contact at a point which is subjected to heavy wear. This eventually develops backlash. The teeth of the gears also come into action with a degree of pressure that is continuous throughout the time of contact; this results in a hammering which in time develops into a humming noise.

Special Hobs for Gear Teeth

To overcome these objections a hob tooth may be developed to generate a curve which will closely resemble that of the formed tooth. Such a hob tooth is shown in Fig. 2. Theoretically, the correction for interference or undercutting should begin at a point located above the pitch line a distance as determined for a twelve-tooth pinion by the expression:

$$0.03133 \times \frac{N}{P}$$

in which N = number of teeth in the smallest gear to be hobbled;
 P = diametral pitch of gear.

However, to begin the correction for interference at this point would reduce the length of the true involute and result in too full a

tooth, causing noisy gears. Therefore, a compromise is made and the correction is obtained for a minimum of twenty-one teeth. To compensate for the extra fullness of the tooth at the root, the point of the tooth is thinned down in proportion, and this is done by leaving the tooth of the hob full below the pitch line by striking an arc from a center on the pitch line, and also employing a large fillet having a radius equal to $0.45 \div P$ (see Fig. 2). It will be noticed that the radius of the arc at the top of the hob tooth is smaller than the radius at the bottom of the hob tooth. This will thin the tooth of the gear in excess of the amount necessary to clear the flank, easing the action and eliminating the hammering effect due to the theoretical contact. It will be seen from the illustration that the thinning of the teeth does not affect the twelve-tooth gear to any appreciable extent, but is gradually increased with the number of teeth. The fact that a twelve-tooth gear will mesh without interference at the point of the teeth

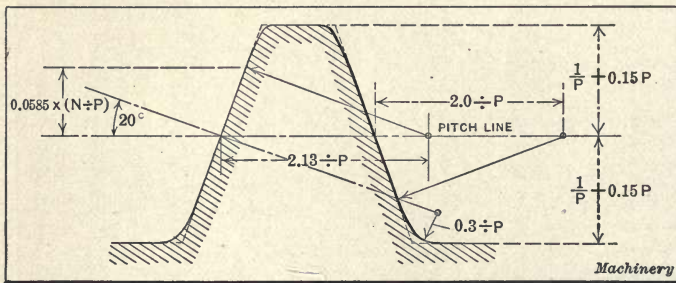

Fig. 3. Hob Tooth for generating a 20-degree Involute Milled Tooth

makes the thinning unnecessary; besides, the small pinions are usually the drivers.

Fig. 3 shows a twenty-degree hob tooth with standard addendum and corrections for non-interference. The curve of the tooth begins at a point 0.702 inch from the pitch line, in the case of a one diametral pitch tooth, and is based on non-interference with all teeth from twelve teeth up.

Fig. 4 shows the shape of the hob tooth to reproduce the stub teeth of the gears generated on the Fellows gear shaper. The particular tooth in the figure is a $6/8$ pitch tooth, and the proportions are given in terms of the pitch numbers so as to be easily applied to the other pitches; thus the height of the tooth above the pitch line is stated as:

$\frac{0.25}{8} + \frac{0.25}{8}$ where 8 is the addendum number of the pitch designation.

The shape of the rack or hob tooth to roll with the gears produced by the gear shaper should be generated from the cutter used. The Fellows cutters have perfect involutes above the base line, with radial flanks, so that the hob tooth would be straight only a distance from the pitch line equal to $0.0585 \times N \div P$, where N is the number of teeth in the cutter; in most cases the cutter would have more than seven teeth and the hob tooth would be straight-sided to the point. In

this system the radial flank of cutters with more than seventeen teeth does not affect the shape of the face of the tooth, as the involute portion of the cutter tooth generates a pure involute. The straight side of the hob tooth should extend to the root in such cases.

To reproduce gears of some standard the exact shape of which is not known, the hob-tooth shape can be easily generated from the gear tooth on the milling machine, as will be explained in a subsequent part of this chapter.

Applications of the Hobbing Process

The hobbing process is not limited to the production of gears, but can be used to generate teeth of almost any shape, such as the teeth of ratchets, milling cutters, reamers with equally spaced teeth, chucking drills, multiple splined shafts for automobile transmissions, cams,

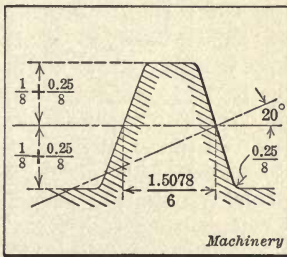

Fig. 4. Hob Tooth for a 6/8 Pitch Fellows System Stub Gear Tooth

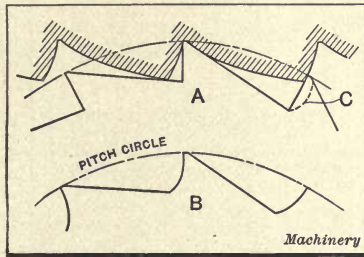

Fig. 5. Diagram showing how Hob may be used for generating Ordinary Ratchet Teeth

sprockets, etc. Fig. 5 shows the shape of hob tooth to generate the teeth of ratchets. There is no shape of tooth that will generate the radial teeth of ratchets of the type shown at A; the nearest that can be obtained is the modified shape at B with the filleted root. Should the tooth of the hob be made straight and normal to the axis of the hob, the tooth produced would be undercut as shown at C.

The shape shown is generated from a 12-tooth radial ratchet and would produce a nearer approach to the radial form in ratchets of a larger number of teeth. The back of the teeth would be concave instead of straight in the case of larger numbers of teeth. A good compromise would be to make the back of the hob tooth straighter, the shape being obtained by generating from a ratchet of, say, forty-eight teeth. The back of the teeth of ratchets of a smaller number of teeth would then be convex in shape. Hobs of this kind have been used successfully in hobbing milling cutters, a single hob covering a limited range of sizes. The difficulty in having a hob cover a wide range of cutter sizes is the fact that the pitch of the teeth is not constant, as in the case of gearing. When making cutters in quantities, the cost of the hob is soon covered by the saving in the manufacture of the cutters over the cost of milling. In the case of spiral cutters, the angle can be altered to make it possible to make the hob cover a

greater range of sizes. The hobbing process is especially adapted to the making of spiral milling cutters.

The form of hob shown in Fig. 6 is a cross between a hob and a formed milling cutter, and can be employed profitably in the milling of radial teeth by the hobbing process. The form is made with a normal face and is generated back as in the case just shown. The hob is set so as to be all on one side of the center of the blank being cut, as shown. The radial face of the tooth is formed with the face of the hob tooth acting as a fly-cutter, the form of the face being a reproduction of the face of the last hob tooth, which is set radial with the axis of the blank. The fronts of the hob teeth are relieved on the sides; this can be done by using the combined side and radial relief

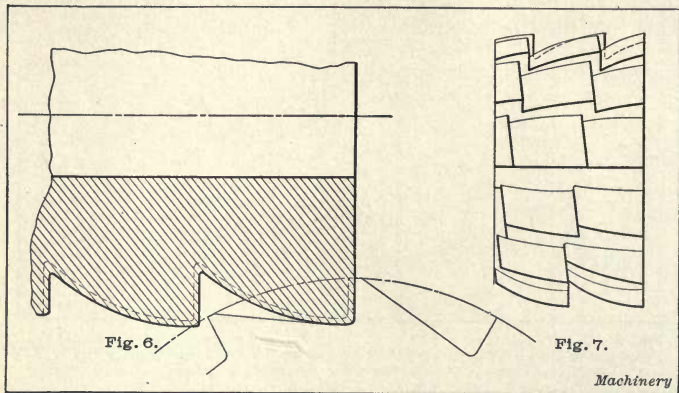

Fig. 6. Type of Hob for generating Ratchet Teeth. Fig. 7. View showing the Relief in the Hob for generating Ratchet Teeth

cams, or, if that combination is not available, the side relief can be given as a separate operation. The latter will cause a widening of the top of the tooth as the hob wears back in sharpening. Fig. 7 shows a view of the hob. The convex shape of the generated form of the hob tooth will have the same effect on the shape of the back of the tooth as stated above in the case of the generated hob. This portion of the tooth cannot be made to act as a fly-tool, as it cannot be set on the radial line and must generate the form by a regular generating action.

A form of hob that can be used to advantage in the automobile industry is that for forming the splines on the transmission shaft. This shaft commonly has six splines, as shown in Fig. 8. The face of the splines or teeth have a negative rake, being set ahead of the radial line, and for that reason can be formed with the hob if the depth and thickness are not too great in proportion to the diameter. In the illustration the proportion is six to one, and the hob form is such as to give a very close approximation to the desired form; however, if the shafts are to be used as left by the hob, that is, without grinding, it would be well to make the broach by the same process to insure a

duplication of shape in the keyways in the gears. In all these special forms the pitch is taken from the outside of the blank; if taken inside of this point, the hob tooth, if radial, would have to be undercut, which is not practical.

In Fig. 9 is shown another shape that could be used to advantage for hobbing squares. Hobs for this purpose could be used in squaring the ends of such shafts as, for instance, the ends of milling machine feed-screws, cross-screws, and the elevating shafts. If there is a job that is handled to disadvantage on the milling machine, it is the squaring of these shafts and screws. A similar hob could be developed for the hobbing of hexagons and other polygon shapes on the ends of shafts, or for the heads of bolts.

The great disadvantage of the hobbing of the shapes just mentioned is the low number of

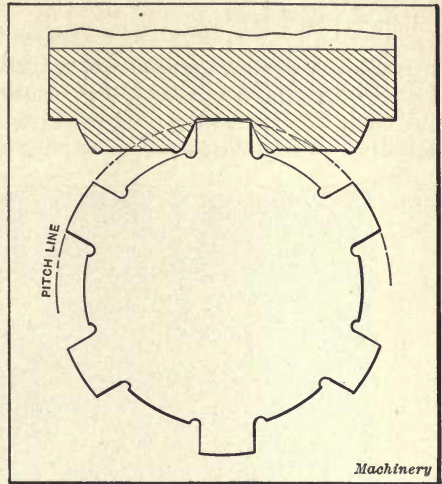

Fig. 8. Hob tooth for generating a Six-spline Shaft

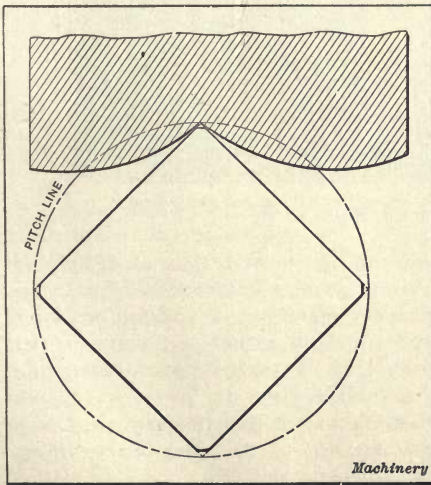

Fig. 9. Hob Tooth Shape for generating Squares

“teeth” or divisions, which necessitates a rapid travel of the index gear and high ratio gears to give the proper spacing, and also the long lead of the hobs. The latter is not so objectionable in the case of the small squares and hexagons generally used, as the lead in most cases can be lower than one inch.

The examples given do not exhaust the field for the hobbing process, but give an array of cases which are out of the ordinary and show the application of the process to other than the ordinary work of gear-cutting.

The shapes have been laid out on the drawing-board in each instance, but a far more accurate way to obtain them is by generating them on the milling machine. This generating process is in

reality a duplication of the hobbing process, but in generating the tooth shape for the hob the process is reversed, that is, the shape to be generated by the hob is used in generating the hob-tooth shape.

Generating Hob-tooth Shapes

In Fig. 10 is shown a milling machine set up for generating the hob-tooth templet. This is done on the universal milling machine, or on the plain milling machine if the screw can be connected up with the worm of the dividing head, as in milling spiral work. The spindle of

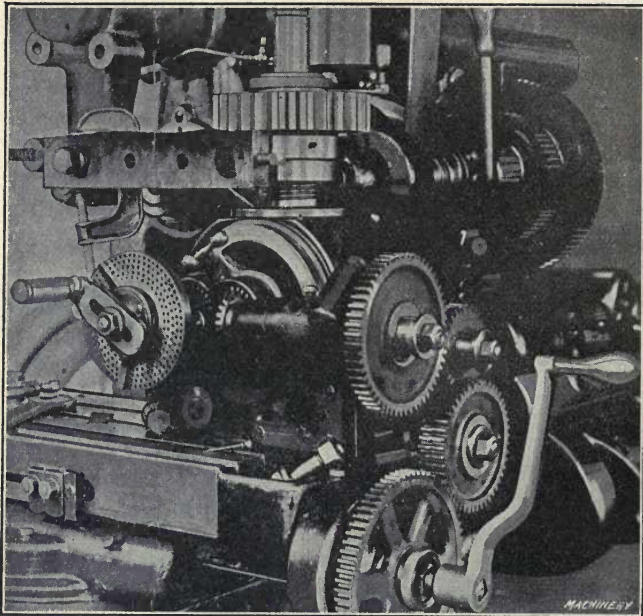

Fig. 10. Milling Machine set up for laying out the Shape of a Hob Tooth

the dividing head is set vertical, and the master gear or templet of the shape it is desired to produce by hobbing is mounted on an arbor in the spindle. In making the master templets, care should be taken to produce the correct shape and to be sure that the shape is true with the hole; if the templet is not true, the shape generated will not be accurate, of course.

The gearing connecting the feed-screw and the dividing head must be for a lead equal to the circumference of the pitch circle of the gear from which the hob templet is generated.

To provide a rest on which the tool templet to be laid out may be clamped, a parallel is bolted to the outer arbor support so as to be horizontal and parallel with the milling machine table and at right angles to the machine spindle. The rest may also be in the form of an angle plate clamped to the face of the column, but the former type

is the most desirable, as it brings the work in a more accessible position.

The blank templet should be a piece of sheet steel about one-sixteenth inch thick, one edge of which should be straight and true and the surfaces smooth and bright. The surface to be laid out can be given a coat of copper solution, or, still better, varnished so that the lines may be etched deeper, as the handling in working out the shape tends to obliterate the shallow lines in the thin copper coat. This blank templet can then be clamped to the rest in a convenient position. There must be plenty of room for the travel of the gear, so as to obtain the proper amount of "roll" to generate the shape desired.

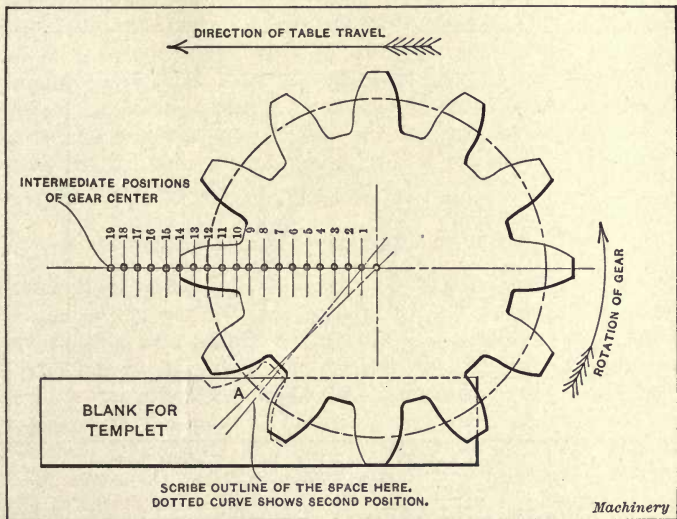

Fig. 11. View showing the Relative Position of Gear and Templet

The true edge of the plate should be parallel with the rest and the direction of the movement of the milling machine table. Adjust the knee vertically so that the plate will come up under the gear on the dividing head so as to just clear it; the saddle can then be adjusted across to bring the edge of the plate in line with the end of a tooth in the gear when the center line of the tooth is about at right angles to the axis of the feed-screw as shown in Fig. 11. In this way the templet is set to the proper position for depth. The backlash should be taken up by turning the screw in the direction in which it is to be used.

Now select a tooth space A, Fig. 11, as the one to be used in the scribing operation, and run the point of a slim, sharp scriber along the outline of the tooth space, scratching the line on the plate; then move the table about one-half turn of the lead-screw and scribe another line, and repeat the operation until the table has been moved through a length equal to three times the circular pitch. When this has been

done the lines on the templet will resemble that in Fig. 12. The lines should now be etched in and the plate polished.

The combined lines on the plate will be seen to describe the rack tooth shape of the hob teeth in a clear-cut manner, if the operation has been carefully carried out. If the gear tooth from which the lines were taken is theoretically correct, the sides of the outline on the plate will be straight a greater portion of the way from the point of the tooth to the edge of the plate; the lines diverge from the straight line at a point near the edge of the plate, as shown by the dotted lines in Fig. 12. This point will be found to be, in the case of the $14\frac{1}{2}$ -degree tooth, at a distance from the pitch line of $0.03133 \times N \div P$, where N is the number of teeth in gear and P the diametral pitch. If

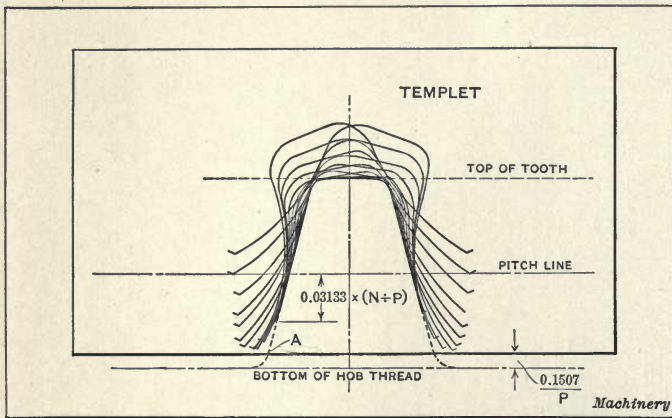

Fig. 12. Lines scribed on the Hob Tooth Templet from a Hobbed Gear

the hob to be made from this form is to be used for N teeth or less, the shape of the templet will be correct, but if the hob is to cut gears of a larger number of teeth, the straight portion of the tooth must be carried down to the edge of the plate in order that the teeth of the larger gears will not be cut away too much at the points.

In making a templet in this way for any other shape than for gears, it should be cut to the lines on the plate, as no correction can be intelligently made in those cases. Some success has been made in the layout of templets for a hob tooth for gears of a limited range of teeth by using the space below the pitch line of the smallest gear in the set and the space above the pitch line of the largest gear in the set as the shape in generating a hob tooth templet. This is of value in generating a hob-tooth shape to reproduce a set of gears milled with formed cutters. However, the best and easiest method is to take the smallest gear in the set as the one from which to generate, and prolong the straight portion of the hob tooth to the edge of the plate, easing the side at A , to point the teeth slightly. The teeth of the hob are generally made with an extra clearance at the bottom as

shown. This is a matter on which authorities differ, some preferring to have the hob cut the top of the teeth, to make the teeth of standard length if the blanks should be over size; however, the general practice is to make the tooth the same length both above and below the pitch line as in Figs. 2 and 3.

If the form is for a generated gear and results in the straight-sided tool in Fig. 12, all that is necessary is to measure the angle and make a thread tool that will cut a thread of this section. Should the shape turn out to be a compound of curves, as will be the case in reproducing the milled tooth, the templet should be filed out to the lines, making a female gage to which a planing tool is made, the planing tool being a duplicate of the hob-tooth shape. The threading tool is planed up with this tool. In making the thread tool, it is not usual to make it of female shape, that is, like the templet, but pointed as usual, planing the sides with the opposite sides of the planing tool. The proper corrections should be made in the thread tool to correspond to the angle of the thread, and the setting of the tool and the fluting of the hob, whether it is gashed parallel to the axis or normal to the thread helix.

Making a Master Planing Tool for a Hob

A master planing tool can be made in the following manner, without the use of the scribed line templet. It is necessary to have a universal milling attachment for the milling machine. The spindle of the attachment is set in the horizontal position with the axis parallel with the direction of the table movement. A fly-tool holder is then placed in the spindle, in which the blank planing tool is to be held. This tool should be roughly formed to the shape to which it is to be finished. The top of the tool should be radial, that is, it should be in the plane of the center of the spindle. The gear or other master templet that it is desired to duplicate by hobbing must be hardened and ground to a cutting edge on one face, preferably the top face when mounted in the spindle of the dividing head, so that the pressure of the cut will be downward. The knee should be adjusted to bring the ground face of the gear to the level of the center of the spindle of the attachment. The dividing head and the table screw are connected in the same way as previously described, but in this case the power feed can be used and the saddle can be fed in to depth as needed, care being taken to use the power feed, in generating the tool, only in one direction, as the backlash in the gears and screw will throw the tool and dividing head out of relative position if used in the opposite direction. As many cuts can be taken as required to obtain a tool of the correct shape.

If the tool is to be used in making more than one threading tool, as might be the case in many instances, the planing tool can be made in the shape of a circular tool which can be ground indefinitely without losing the shape. In this case the fly-tool holder would give place to the standard milling machine arbor. This method is the most ac-

curate way of making the master planing tool, and where the universal milling attachment is available, it should be used where accurate results are desired. It eliminates the human element and the amount of skill required in making the master templet. The inaccuracy of the machine is the only element that is likely to cause error.

One point that is likely to cause difficulty is the relation of the generated tool shape to the thread shape, as it appears in the normal section of the hob tooth. The simple fact is that the master tool shape, as generated by the direct method of making the master planing tool, or the shape as outlined on the hob tooth templet in the first method, is the shape of the cross-section of the hob thread on a plane normal to the hob thread helix. This relation should be kept in mind throughout the process of making the tools and hob. This statement also clears any haziness regarding the question of the lead, as in single-threaded hobs this must be such that the normal pitch of the thread is equal to the circular pitch of the teeth hobbled. In the case of hobs of small thread angles, the normal and axial leads are practically the same, and may be treated as such in cases where the angle is less than 2 degrees and the pitch less than $\frac{1}{2}$ inch; an error of more than 0.00025 inch should not be exceeded in any case. The effect of the error is apparent in the case of a 6 diametral pitch hob 3 inches in diameter, when the axial lead is taken as the circular pitch of the teeth, as it results in an error of more than one-half degree in the pressure angle of the hobbled tooth. Only in extreme cases should the angle of the hob thread be more than ten degrees. Hobs with greater angles than this are difficult to make and use. In hobs of long lead the diameter should be proportioned so as to obtain a reasonable angle of thread. However, the extreme in diameters is as bad as the steep angles, and in cases where the two extremes are met a compromise is the only solution.

The method used in laying out the tooth shapes on the drawing-board is an interesting study, but the method of generating the tool as described is the most useful, and can be relied on for accurate results; this is not the case with the drawing-board method which is of value only as a means of getting an approximate shape.

CHAPTER III

THE CENTERING OF THE HOB IN GEAR HOBBING

Whether or not it is necessary to center the hob in order to get satisfactory results in gear hobbing, is a question that is not so readily answered as it might appear. For the sake of making the matter clear to those who have not the time to make a study of the subject, the results of an investigation conducted by the writer will no doubt be of interest. Theoretically speaking, there should be no difference in the results whether the hob is centered or not. However, practical modifications enter into the actual conditions and exert peculiar effects upon the results produced. To briefly explain the action of the hob, we may say that the generating operation consists

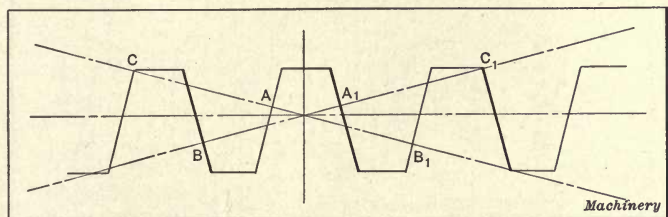

Fig. 1. Diagram showing Points of Intersection of the Pressure Lines with the Hob Teeth equally spaced at each Side of the Pitch Point

of a successive trimming of the teeth of the gear by those cutting edges of the hob that are located in the generating path. The portion of the cutting edge that forms the tooth of the gear lies on the pressure line of the hob, intersecting the pitch point, and the maximum length of the hob in this generating space is $2s \div \tan \phi$, where s equals the addendum or the reciprocal of the diametral pitch and ϕ equals the pressure angle; in case of small pinions this length may be as short as the circular pitch of the teeth.

The point where the two opposite pressure lines cross the pitch line is the center of the hob, and the object of centering is to get corresponding portions of the generating edges at equal distances on each side of the center, so that the sides of the teeth generated will be symmetrical. Thus in Fig. 1, the points where the pressure lines intersect the teeth of the hob at A , A_1 , B , B_1 , and C , C_1 , are at an equal distance on each side of the center or pitch point, and at a like distance from the axis of the hob when the pitch point lies in the center of a tooth or space as shown. If the pitch point is shifted out of the center of the tooth or space, the radial distances of the respective points of intersection are not equal, the points A , B and C being a greater or less distance from the axis than the points A_1 , B_1 , and C_1 .

There are defects in the hob that cannot be compensated for by any amount of centering, and the generating of symmetrical teeth cannot be insured. Among these we may cite the defects due to distortion in hardening, unequal tooth thickness due to springing of the tool in forming, and errors in size resulting from careless workmanship. The defect that can be favored in the setting of the hob is that in which the eccentricity of the form and axis causes the teeth to run out. This eccentricity may be caused by the use of an inaccurate mandrel in the backing-off operation or by not truing up the hob properly in grinding the hole; it may also be caused by an untrue hob arbor on the hobbing machine itself. These defects can be determined and proper allowance made to counteract the natural results by a careful setting of the hob. By knowing what result will be obtained with these eccentric hob conditions the defect can be

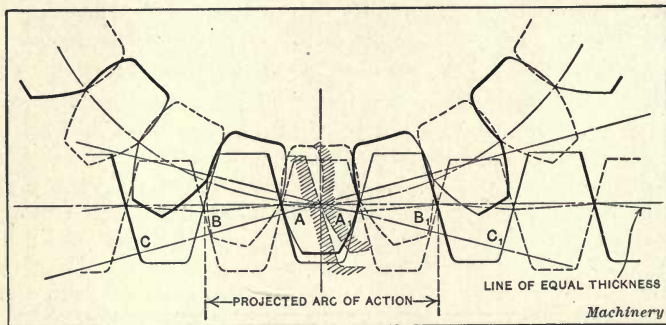

Fig. 2. Case I. Hob with Low Tooth and High Space centered.
Full Lines show High Side and Dotted Lines show Low Side

diagnosed and a remedy applied, or, at least, the setting can be made to favor the defective conditions.

Let us take the most common condition—the case where the axis of the form and that of rotation are eccentric and parallel—and treat it as follows: Case I. Hob with low tooth and high space centered. Case II. Hob with high tooth or low space centered. Case III. Hob not centered, but half way between the conditions of the two preceding cases.

Case I for Fourteen and One-half Degree Teeth

The method of treatment is to take a normal gear and show it in mesh with the eccentric hob in the desired position: in this case, with the "high" space centered. This setting brings the tooth on the opposite side of the hob in the center if the number of gashes are even, and this opposite side is the "low" side of the hob. This is shown in Fig. 2. In each case, the high side is shown in full lines and the low or opposite side in dotted lines. The intermediate teeth which range from high to low are not shown except in the central position in Figs. 2 and 5, and in the extreme positions in Fig. 8. An inspection of Fig. 2 will show that the pitch line of the hob, considered in its

relation to the tooth itself, does not lie along a straight line parallel to the axis of the hob, but on a zigzag line that is shown broken. This line represents the pitch location of the right side of the hob tooth, and may be termed the "line of equal tooth thickness." It will have a drop for each pitch length of the hob for every convolution of the thread. In reality, the line instead of being zigzag should be a reverse curve.

In the central position indicated by the full lines, the contact between the teeth of the hob and gear is normal and correct. If the hob be given one-half revolution, the position taken is indicated by the dotted lines and it will be noticed that the gear and hob do not come into contact as they should at the points B and B_1 , the space widening from the points of contact A and A_1 to the points B and B_1 . From this we may rightly assume that the hob would form the teeth

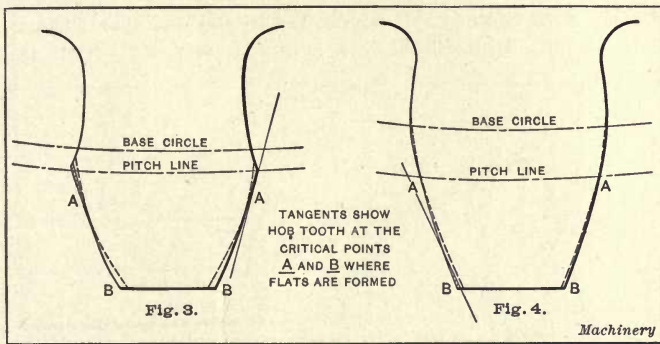

Figs. 3 and 4. Tooth Outlines showing how Flats are formed at the Pitch Line and at the Point in Case I

of the gear with a fullness at the point, as indicated by the full line from A to B in Fig. 3. The dotted line shows the normal curve of the tooth. If the hob is given a quarter turn from the full line position, the relative position of the teeth of both the gear and hob is at the dotted line position shown in the center of Fig. 2, midway between the teeth instead of giving the normal contact at the pitch point on the pitch line of both gear and hob. This should develop a fullness of the gear tooth at the pitch line diminishing again to normal at the point A . But the normal position of the hob tooth at the point A brings the edge of the hob tooth inside of this bulge, so that it would remove the greater portion of it shown in cross-section in Fig. 3, leaving a flat from the point A extending to the pitch line. In exaggerated cases, in cutting large numbers of teeth, the flat will extend past the pitch line to the base of the involute.

When the projected arc of action shown in Fig. 2 is greater than twice the pitch of the teeth, which is the case when cutting gears with a greater number of teeth than 36, the trimming of the involute portion of the teeth takes place through two or more turns of the hob instead of one. This brings the tooth of the hob more nearly into

the normal position at the end of the gear tooth, tending to make the point of the tooth nearer to the proper thickness; but the correct thickness is never reached as it would be necessary for the contact to continue to the position *C*, which is the case of a gear of infinite diameter. This develops a flat at the point of the tooth for the same reason as that given for the flat produced at the pitch line. The result of this action on gears with teeth greater in number than 36 is illustrated in Fig. 4, where the cross-sectioning shows the excess metal removed, resulting in the production of the flat. The effect on the flank of the tooth need not be taken into consideration; as the hob leaves it, there is ample clearance for the gear tooth of the mating gear, it being only in the case of a gear meshing with a rack that the flank would be apt to give trouble.

Case II for Fourteen and One-half Degree Teeth

The high tooth centered, as illustrated in Fig. 5, shows the normal contact between the teeth at the points *B* and *B*₁. With the hob

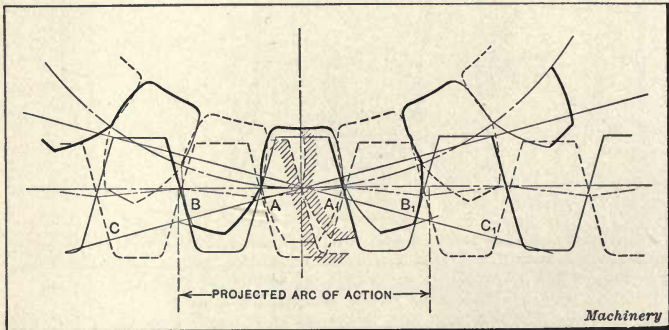

Fig. 5. Case II. Hob with High Teeth and Low Space centered.
Full Lines show High Side and Dotted Lines show Low Side

revolved one-half turn, the low space comes into the central position, but there is no contact between the teeth at the points *A* and *A*₁. In the central position where the pitch lines of the gear and hob are tangent, instead of the normal contact we have a space between the teeth. A gear generated with the hob set in this position would have teeth of the form illustrated in Fig. 6, with fullness at the points *A* and a perceptible flat below the pitch line, which extends to the base circle in gears with a large number of teeth. In the case of gears with more than 36 teeth, the normal contact at the points *B* and *B*₁ develops into a space and results in a flat at the point of the teeth, as shown in Fig. 7.

The two preceding cases give the two extremes in setting the hob central and show the results of eccentricity of the axis of form and the axis of rotation. Of the two methods, the latter is the more practical. By centering the high tooth the depth is easily obtained, whereas in the first case with the high space centered, the depth is not so easily obtained because the centered tooth is the low tooth and if

the hob is fed to depth after bringing it so as to mark the blank, the depth will be deeper than that shown in Fig. 2 and the tooth thickness will be under size. The reverse is the case with the second method of setting, but to obtain the proper tooth thickness the hob will have to be fed in deeper than the standard amount. The pointing of the tooth at *B* in Case II will give better running gears than the fullness at the point as in Case I.

Case III for a Fourteen and One-half Degree Tooth

By moving the hob along so that the pitch point lies on the edge of the high tooth, as in Fig. 8, we have a case which gives results similar to those obtained by setting the hob at random, and we will get results more or less unsymmetrical. The full lines in Fig. 8 show the high side of the hob in normal contact with the gear teeth, with contacts at the pitch point and at the point A_1 . On bringing the hob into the

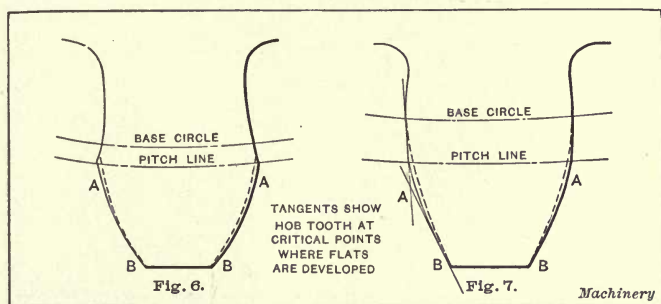

Figs. 6 and 7. Tooth Outlines showing Points at which Flats are produced in Case II

opposite position with the low side, or to the location shown by dotted lines, we find no contact at the pitch point nor at point *A*. Rolling the gear until the teeth come to the end of the normal point of contact on the pressure line at *B* and B_1 on each side of the pitch point, we will find a space at B_1 instead of the contact as at A_1 , and a lessened space at *B*. Had this rolling brought the gear tooth to the low hob tooth position, as at C_1 , the space at B_1 would have been maximum and the position at *B* would come into contact with the high tooth at *C*. Further rolling of the gear away from these positions would tend to reduce the space to the right and to develop a space to the left.

A hob in this condition and so set would generate a tooth with the left side normal at the pitch line, with a bulging face; and with the right side full at the pitch line and nearly normal at the point of the tooth, with a flat near the point when the hob is cutting to depth. The case of a twelve-tooth pinion is shown in Fig. 9; and the case of a larger gear in which the contact between the teeth of gear and hob continues to the point *C* of Fig. 8 is illustrated in Fig. 10. In both cases, the last "swipe" of the hob tooth will cover a broader length of the tooth than it ought to, and will leave a flat at the point on the left side of the tooth. Similarly, in the case of both Figs. 9 and 10,

the hob tooth in the position A_1 of Fig. 8 will leave a flat at this point covering considerable of the right side of the tooth face. The cross-sectioned areas show portions of the bulges cut away, leaving flats.

The method outlined in Case III has the same effect as centering any of the teeth of the hob except the high or low tooth, so that the usual procedure of shifting the hob to bring new cutting points into position will result in unsymmetrical teeth being developed in the gear if the hob runs out of true with the axis of rotation. The actual amount of the distortion in the teeth generated will depend upon the amount of eccentricity of the hob form and is approximately one-fourth of the eccentricity on each side of the tooth. In Fig. 3, for example, the amount that the tooth is thick at the point B , for a hob 0.002 inch eccentric, will be 0.0005 inch on each side or 0.001 inch altogether. The amount of the space at the pitch line would be the

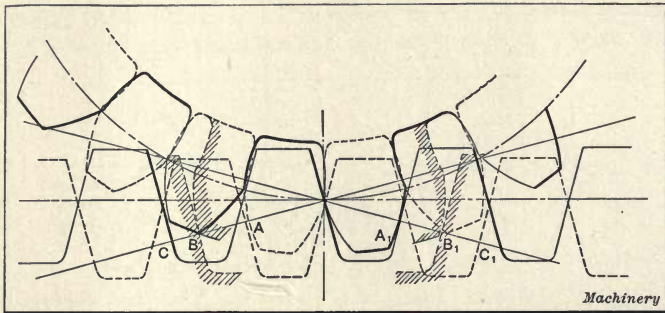

Fig. 8. Case III. Hob centered midway between Positions in Case I and Case II

result of only one-half the eccentricity, as the tooth is in the mean position at this point.

Consideration of Other Cases

Several cases could be treated in this way, as for instance, the case where the axis of form is not parallel with the axis of rotation but where these axes intersect. The only remedy that would make it possible to obtain symmetrical teeth would be to find the point of intersection of the axes and set the hob central with that point. But instead of setting the high tooth central, as in Fig. 5, the hob should be set in such a position that the axis of the form lies in the same plane as the spindle on which the gear is placed, and the hob should be set central irrespective of the location of the teeth of the hob. That is, the hob should be set so that the point of intersection of the two axes will lie directly in line with the axis of the work spindle of the machine, whether or not the tooth of the hob comes central. Of course if a tooth comes into this position, so much the better for the symmetry of the teeth of the gear. This setting is illustrated in Fig. 11. The unsymmetrical results sure to be developed by any other setting are quite obvious without further exposition.

Defects in Hobs

The preceding treatment of three typical cases throws some light on the cause of the poor shape of the teeth so often complained of in the results obtained from the hobbing machine, and while this discussion does not include all of the defects that will produce similar results, it does emphasize the fact that more care will be necessary in the preparation of the hob than has formerly been the practice. Eventually we shall have the ground hob, with the defects of hardening and careless forming eliminated by grinding the hardened hobs on precision machines in which the human element will be reduced to a minimum, so far as its effect on the accuracy of the hob is concerned. When such hobs are available, the hobbing process will meet with little or no opposition based on the unreliable results obtained by it. However, until the ground hob is perfected, flats and

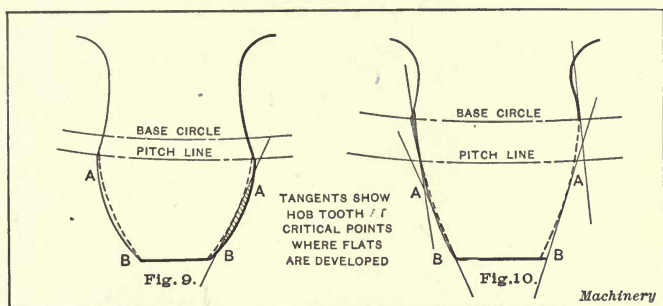

Figs. 9 and 10. Tooth Outlines showing Flats produced by Hob set according to Conditions of Case III

unsymmetrical tooth outlines will be a source of worry to the user of the hobbing machine and he will meet the results already pointed out in Chapter I. In that chapter, a remedy is given to reduce the effects of careless workmanship, and a further means of correcting such defects and distortions of the hob teeth is outlined in the following paragraphs.

This consists of the more direct process of grinding out the distortion of the teeth from the narrow helical path, and of bringing their cutting edges back into the proper helical relation with each other. All that is necessary for the operation is a toolpost grinder—preferably an electric machine. Of course it goes without saying that the more carefully the performance is carried on, the more satisfactory will be the results obtained.

The procedure is simply this: Set the lathe to the proper lead of the hob, with the toolpost grinder on the slide-rest, and with a clean cutting wheel grind the edge of the side of the teeth into the proper helical relation. It is necessary to be careful not to grind too much from the side of the teeth; just let the wheel touch the teeth all the way around, and if the mandrel on which the hob is held is running true, the hob thread will be straightened up. It will be noticed that

the land left by the wheel is not uniform and the amount that the teeth are out of true is directly proportional to the width of this land. It will also be noticed that some rows of teeth will have wide land while those of the opposite side of the hob will have narrow lands; this is the result of the eccentricity of the axis of form with the axis of rotation and should be corrected by grinding the teeth back until the lands are of uniform width. This is the same treatment that was given for the correction of careless spacing and improper sharpening in the first chapter of this treatise. Besides this regular variation in the width of the ground lands, other irregular lands will be

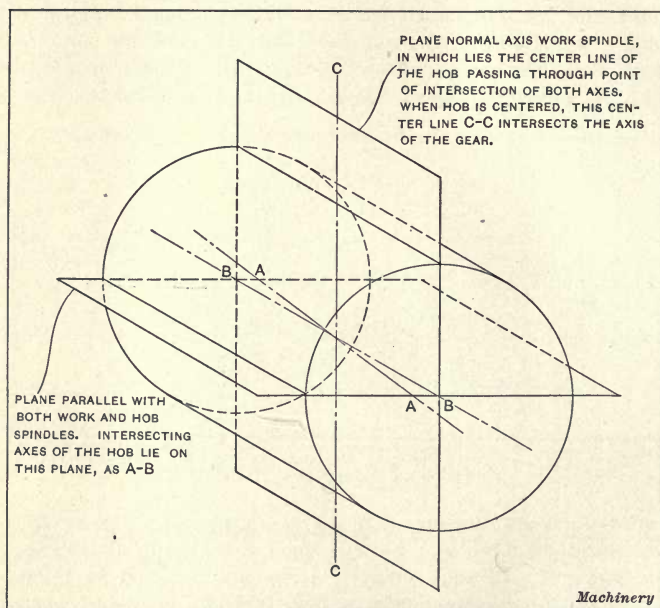

Fig. 11. Method of setting Hob when Axes of Form and Rotation intersect

noticed which are the result of singly distorted teeth, due to careless forming or to distortion in hardening. If the land left by the wheel is not so wide as to cause the teeth to drag on account of the relief being ground away, they may be allowed to remain in the condition as left by the wheel, or they may be treated singly by grinding back as in sharpening.

The results obtained by this treatment more than pay for the time and expense, and where a hob is giving trouble this remedy is recommended. A hob thus treated need not be centered, as the teeth generated by it will be symmetrical by the most rigid test usually applied to commercial work. The treatment will have to be repeated at each sharpening, however, to insure the continuance of the good results. In choosing the change gears for the lathe, the axial lead corresponding to the normal pitch of the teeth must be used; and as a

difference of 0.0005 inch is noticeable in the angle of the teeth, the lead must be closely followed. Some such treatment as this is necessary with the irregular hobs now obtainable.

Conclusion

The answer to the question: Should the hob be centered? thus, is that with the unground hob in which the eccentricity is an unknown quantity, but may be taken as sure to exist, it is well to center the high tooth as in Case II; and with the accurate hob, that will be available when the methods of grinding the teeth are perfected, it will be unnecessary to center the hob *if* the hob has been carefully sharpened and the hob arbor runs true on its axis. While the results revealed by the treatment of the three cases seem to be unfavorable to the hobbing process, it is such studies as these that bring the truth to light and lead the way to the remedy which, when applied, brings to the hobbing process the share of consideration it deserves as one of the simplest and most efficient methods for the production of the teeth of gears.

CHAPTER IV

HOBGING VS. MILLING OF GEARS

The adverse criticism of the gear hobbing process has been the cause of many interesting investigations, and one of the most important of these has been the comparative study of the condition of the surfaces produced by the hob and by the rotary cutter. In making such a comparative study, it is necessary that the investigator possess the required practical knowledge, and also that he be willing to admit a point, even though his favorite processes may suffer by the comparison.

Feed Marks produced by Rotating Milling Cutters

While both the gear hobbing machine and the automatic gear cutter use rotating cutting tools, the operations cannot be placed on a common basis and considered as similar milling operations, although they may, to a certain extent, be compared as such. In comparing the quality of the surfaces produced by the two processes, consider first the milled surface produced by an ordinary rotary cutter. This surface has a series of hills and hollows at regular intervals, the spacing between these depending upon the feed per revolution of the cutter, and the depth on both the feed and the diameter of the cutter. The ridges are more prominent when coarse feeds and small diameter cutters are used. These feed marks are the result of the convex path of the cutting edge and the slight running out of the cutter, which

is inevitable in all rotary cutters with a number of teeth. As is well known to those familiar with milling operations, the spacing of the marks does not depend on the number of teeth in the cutter. Theoretically, it should depend on this number, but as it is practically impossible to get a cutter which will run absolutely true with the axis of rotation, only one mark is produced for each revolution, and, hence, the spacing becomes equal to the feed per revolution. The eccentricity of the cutter with the axis of rotation is, therefore, the factor which, together with the diameter of the cutter and the feed per revolution, determines the quality of the surface, other conditions being equal.

The depth of the hollow produced by the high side of the revolving cutter is equal to the height or rise of a circular arc, the radius of which equals the radius of the cutter, and the chord of which equals the feed per revolution. (See Fig. 1). The length of the chord or the feed per revolution may be expressed:

$$F = 2 \times \sqrt{2HR - H^2}$$

in which F = feed per revolution;

H = height of arc;

R = radius of cutter.

Since H^2 is a very small quantity, it may be discarded in the expression, which is then simplified to read:

$$F = 2 \times \sqrt{HD}$$

in which D = diameter of cutter.

Transposing this expression, we obtain $H = \frac{F^2}{4D}$, which is an approximately correct expression of the depth of the hollows produced by milling. As an example, take an 8-pitch rack cutter, with straight rack-shaped sides, 3 inches in diameter, milling with a feed per revolution of 0.1 inch. The depth of the feed marks at the bottom of the cut will be equal to:

$$\frac{(0.1)^2}{4 \times 3} = 0.00083 \text{ inch.}$$

The working surface of the tooth, however, is produced by the side of the cutter, as illustrated in Fig. 2, and the depth of the feed marks is normal to the surface, and is expressed as:

$$d = H \times \sin \alpha$$

in which d = depth of the feed marks on the side of the tooth, and α the angle of obliquity. In the example given, the depth d would equal 0.00021 inch, for a $14\frac{1}{2}$ -degree involute tooth.

The depth of the feed marks is inversely proportional to the diameter of the cutter, and is, therefore, greater at the point of the tooth than at the root. In the example given, the depth would be 0.00025 inch at the extreme point of the rack tooth. It is thus ap-

parent that the quality of the surface at any position along the tooth from the root to the point depends upon the diameter and form of the cutter and the feed per revolution.

In Fig. 3 is shown the outline of a No. 6 standard 14½-degree involute gear cutter. This outline, at the point close to the end of the tooth of the gear, is a tangent inclined at an angle of 45 degrees, as indicated. Hence, the depth of the revolution marks is:

$$\frac{(0.1)^2}{4 \times 2.5} \times \sin 45^\circ = 0.000707 \text{ inch, instead of } 0.00024 \text{ inch, as in the}$$

case of the straight rack tooth. It is evident that to produce an equal degree of finish with that left by the rack cutter, the feed must be considerably less for a No. 6 involute gear cutter than for the rack cutter. In Fig. 5 is shown the full range of cutter profiles from Nos.

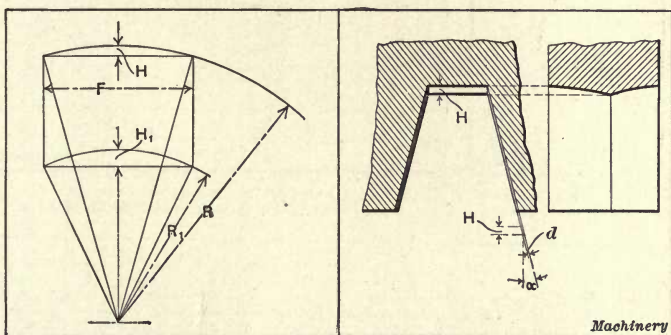

Fig. 1. Diagram illustrating the Relation between Feed, Diameter of Cutter and Depth of Feed Marks

Fig. 2. Diagram for finding Depth of Feed Marks on Side of Tooth cut by Milling Cutter

1 to 8, with the angle of the tangent in each case which determines the quality of the surface under equal conditions of feed and diameter of cutter.

If the depth of the feed marks is used as the determining factor in comparing the condition of the surfaces produced by a series of cutters, it is evident that if the surface produced by the rack cutter is taken as a standard, the feed for cutting a pinion must be considerably less than the feed used for cutting gears with a large number of teeth. In fact, if a rack cutter is fed 0.100 inch per revolution, a No. 8 standard involute gear cutter should not be fed more than 0.055 inch per revolution to produce an equally good surface. The feed is proportional to the square root of the reciprocal of the sine of the angle of the limiting tangent.

If we assume the accuracy of the surface left by the straight-sided rack cutter as equal to 100 per cent, then the relative feeds required for cutting gears with any formed cutter can be calculated. This has been done, and the results are shown plotted in curve A, in Fig. 6. This curve is based on an equal depth of the feed marks for the full range of numbers of teeth in the gears. If, on the other hand, the surfaces

left by the cutter for a given feed per revolution are compared, the depth of the feed marks will vary with the sine of the angle of the limiting tangent, and taking the straight-sided rack cutter as a basis, the relative accuracy of the surfaces is inversely proportional to the sine of the angle, and is plotted in curve *B*, in Fig. 6.

Comparison between Surfaces produced by Milling and Hobbing

A relation has now been established between the quality of the surface and the permissible feeds for cutters for cutting gears with any number of teeth. We will now consider the condition of the surface produced by a hob in a gear hobbing machine. The hob is made with straight-sided rack-shaped teeth and with sides of a constant angle, and is used to produce gears with any number of teeth. We may there-

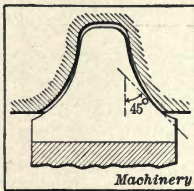

Fig. 3. Angle which limits the Feed

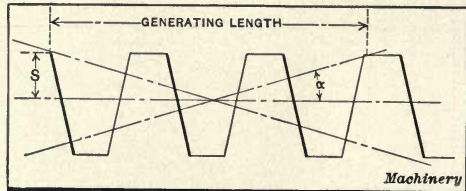

Fig. 4. Diagram for deducing Formulas for analyzing Action in Gear Hobbing Machine

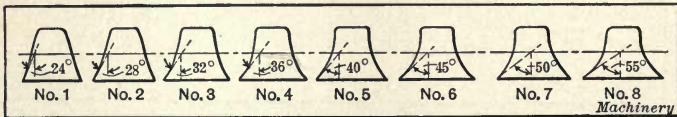

Fig. 5. Angles limiting the Feed for $14\frac{1}{2}$ -degree Standard Gear Cutters

fore assume that it is cutting under the conditions governing the rack cutter, as just explained, the surface produced being considered merely as a milled surface. If this assumption be correct, then the quality of the surface produced by a hob, whether cutting a gear of twelve teeth or of two hundred teeth, will be the same for a given feed, and the same relation exists between the hob and any formed cutter that exists between the rack cutter and any formed cutter; hence, curves *A* and *B*, in Fig. 6, may be assumed to show the permissible feeds and the quality of the surfaces produced by formed cutters when compared with the surfaces produced by a hob, provided the surfaces are considered merely as milled surfaces. However, a condition enters in the case of the hob which has no equivalent in the case of the formed milling cutter, and this influences the condition of the surface. This condition is the distortion of the hob teeth in hardening which causes them to mar the surface of the tooth by "side swiping," producing a rough surface. The eccentricity of the hob with the axis of rotation also has a different effect on the surface than in the case of a formed gear cutter. The effect is shown in a series of flats running parallel with the bottom of the tooth, if excessive; if the eccentricity

is small, the effect will merely be to round the top of the tooth. These inaccuracies, however, can be taken care of in a number of ways.

Comparison of Output

For reasons not connected with the quality of the surface, the hob may be worked at a greater cutting speed and feed than a rotary cutter, when cutting from the solid, the reason being due to the generating action of the hob which results in the breaking of the chips. This preserves the cutting edges and reduces the heating effect of the cut, and explains why the hob may give such good results as compared

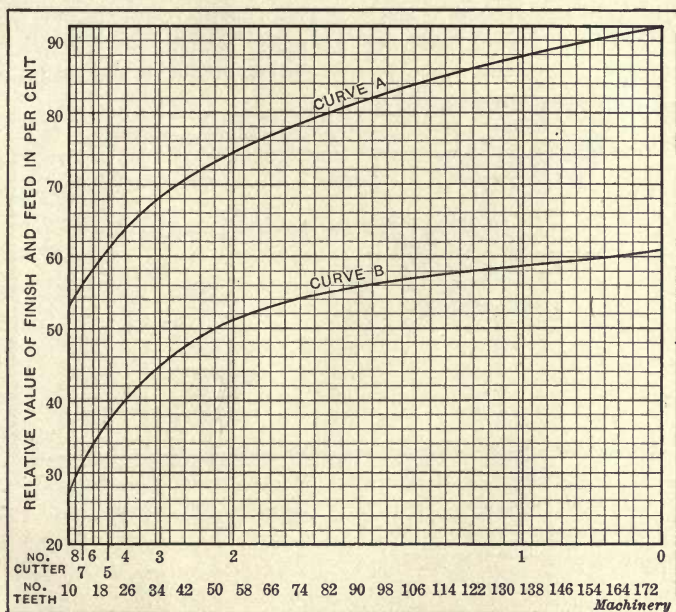

Fig. 6. Diagrams showing the Relation between Feed, Finish, and Number of Teeth when cutting Gears with Formed Gear Cutters

with a rotary cutter in the matter of output. It is possible to get good results in the general run of work in the hobbing machine in one-third to one-half of the time required in an automatic gear cutter. The accompanying table gives the results obtained on automobile transmission gears with automatic gear cutting machines and hobbing machines. If anything, the conditions under which the comparisons were made favored the automatic machines. The speed of the cutter in all cases was 120 revolutions per minute, except in the case of the 13-tooth pinion, when the speed was raised to 160 R. P. M. to increase the output. The hob was run at a speed of 105 R. P. M., in all cases. The results were obtained in producing an ordinary day's work and clearly indicate the advantage of the hobbing process over the milling process,

when the quality of the tooth surface alone is considered, on the basis that both processes produce a milled surface.

The Tooth Outline

Going further into the subject, we will take up the question of the tooth outline. The tooth of a gear milled with an ordinary milling cutter must be, or at least is expected to be, a reproduction of the outline of the cutter, and since each cutter must cover a wide range of teeth, the outline is not theoretically correct, except for one given number of teeth in the range. Theoretically speaking, the outline of the hobbled tooth may be considered as a series of tangents, the tooth surface being composed of a series of flats parallel with the axis of the gear. To show the significance of these flats, assume, for example, that a gear with thirty-two teeth is cut with a standard hob, 8 pitch, 3

COMPARISON OF TIME REQUIRED FOR CUTTING GEARS ON AUTOMOBILE GEAR CUTTING MACHINES AND HOBBING MACHINES

Number of Teeth	Automatic Gear Cutters		Gear Hobbing Machines	
	Feed, Inches	Time, Minutes	Feed, Inches	Time, Minutes
30	0.022	15	0.050	6.5
31	0.020	19	0.050	9
24	0.024	22	0.050	6
17	0.020	8	0.050	4
17	0.020	17.5	0.050	5
16	0.018	10.5	0.050	7
18	0.018	6.25	0.050	6

inches in diameter, having twelve flutes. The length of the portion of the hob that generates the tooth surface is $2S \div \tan \alpha$, where α is the pressure angle, as indicated in Fig. 4. The number of teeth following in the generating path is:

$$\left(\frac{2S}{\tan \alpha} \div \text{circular pitch} \right) \times \text{number of gashes}$$

In this case, the generating length is approximately 0.96 inch, and there are thirty teeth in the generating path. The flats of those parts of the tooth outline which each of the hob teeth form vary in width along the curves. They are of minimum width at the base line and of maximum width at the point of the tooth. The width of the flats at the pitch circle is proportional to the number of teeth in the gear, the number of gashes in the hob, and the pressure angle. The angle β , to the left in Fig. 7, which is the angle between each flat, is proportional to the number of teeth in the gear and the number of gashes in the hob. In the example given, it is:

$$\beta = \frac{360 \times \frac{0.96}{3.1416 \times 4}}{30} = 0.91 \text{ degree, or } 55 \text{ minutes.}$$

The Width of Flat Produced

The width a of the flat at the pitch line is equal to twice the tangent of one-half β times the length of the pressure line between the point of tangency with the base line and the pitch point, and is:

$$a = 2 \tan \frac{1}{2} \beta \times \tan 14\frac{1}{2}^\circ \times 2 = 0.0081 \text{ inch.}$$

This is not a flat that could cause serious trouble. As in the case of the feed marks, it is not the width of the flat alone that is to be considered, but the depth must be taken into account; in fact, the quality of the surface may be spoken of as the ratio of the depth to the length of the flat. The depth of the flat is the rise or height of the arc of the involute and is approximately proportional to the versed

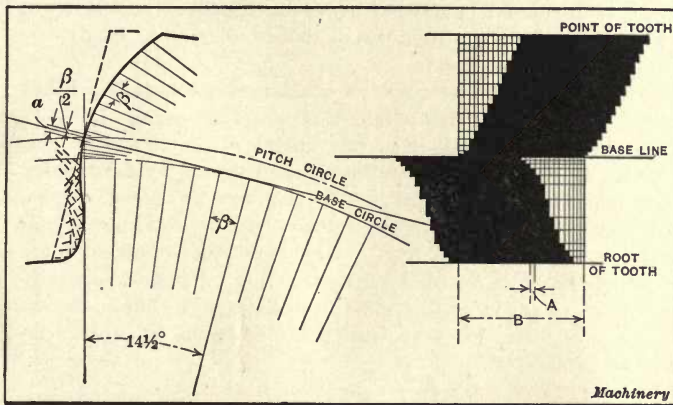

Fig. 7. Relative Width and Position of Flats produced by Gear Hobbing Machines. A indicates Feed per Each Generating Tooth; B, Feed per Revolution of Blank

sine of the angle $\frac{1}{2} \beta$, and with the pitch assumed in the example given, would be 0.000015 inch. It is difficult to conceive of any shock caused by this flat, as the gear teeth roll over each other. The action of the hob and gear in relation to each other further modifies the flat by giving it a crowning or convex shape. In fact, the wider the flat the more it is crowned. This explains the fact that hobs with a few gashes produce teeth of practically as good shape as hobs with a large number of gashes. It is desirable, therefore, to use hobs with as few gashes as possible, because from a practical point of view the errors of workmanship and those caused by warping in hardening increase with the number of flutes.

A peculiar feature of the hobbed tooth surface is shown to the right in Fig. 7, which illustrates the path on a tooth produced by a hob in one revolution. In fact, there are two distinct paths, the first starting at the point of the tooth and working down to the base line, the cutting edges of the hob tooth then jumping to the root of the tooth and working up to the base line, producing the zigzag path shown.

Conclusion

That the flats so commonly seen in the results obtained from the hobbing machine are not due to any faults of the process that cannot be corrected, but are due to either carelessness on the part of the operator in setting up the machine without proper support to the work or to the poor condition of the hob or machine, and that nearly all cases of flats can be overcome by the use of a proper hob, may be assumed as a statement of facts. When the hobbing machine will not give good results, the hob is in nearly all cases at fault. If a gear is produced that bears hard on the point of the teeth, has a flat at the pitch line or at any point along the face of the tooth, do not think that the process is faulty in theory, or that the machine is not properly adjusted, or that the strain of the cut is causing undue torsion in the shafts, or that there is backlash between the gears in the train connecting the work and the hob; these things are not as likely to cause the trouble as is a faulty hob.

After an experience covering all makes of hobbing machines, the writer has come to the conclusion that the real cause of the trouble in nearly every case is a faulty hob. Machine after machine has been taken apart, overhauled and readjusted, and yet no better results have been obtained until a new and better hob was produced. The faults usually met with in hobs were referred to in Chapter I, and the means for getting the hob into a good working condition were also explained there. It is not desired in any way to disparage the formed cutter process in favor of the hobbing process, but simply to state the facts as they appear. In every case, practice seems to substantiate the conclusions arrived at.

THIS BOOK IS DUE ON THE LAST DATE
STAMPED BELOW

AN INITIAL FINE OF 25 CENTS

WILL BE ASSESSED FOR FAILURE TO RETURN
THIS BOOK ON THE DATE DUE. THE PENALTY
WILL INCREASE TO 50 CENTS ON THE FOURTH
DAY AND TO \$1.00 ON THE SEVENTH DAY
OVERDUE.

FEB 17 1936

22 Jan '53 HK
JAN 22 1953 LD

25 May 54 LO

~~25~~ JUN 6 1954 LU

2 Aug '59 AJ

REC'D LD

JUL 19 1959

LIBRARY USE ONLY
MAR 29 1993
CIRCULATION DEPT.

REC CIRC MAR 29 1993

TJ7

M3

V1133

3 47 597

Machinery's

UNIVERSITY OF CALIFORNIA LIBRARY

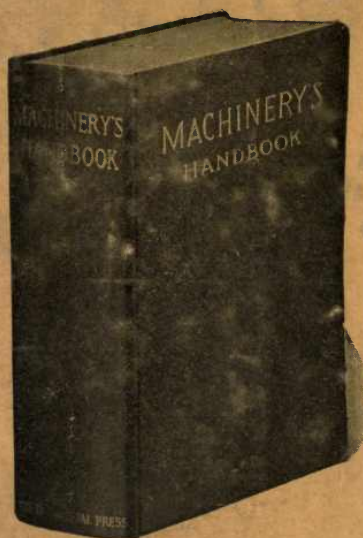

MACHINERY'S HANDBOOK

For MACHINE SHOP
AND DRAFTING-ROOM

A REFERENCE BOOK ON MACHINE
DESIGN AND SHOP PRACTICE FOR
THE MECHANICAL ENGINEER,
DRAFTSMAN, TOOLMAKER AND
MACHINIST.

MACHINERY'S Handbook comprises nearly 1400 pages of carefully edited and condensed data relating to the theory and practice of the machine-building industries. It is the first and only complete handbook devoted exclusively to the metal-working field, and contains in compact and condensed form the information and data collected by MACHINERY during the past twenty years. It is the one essential book in a library of mechanical literature, because it contains all that is of importance in the text-books and treatises on mechanical engineering practice. Price \$5.00. (£1).

GENERAL CONTENTS

Mathematical tables—Principal methods and formulas in arithmetic and algebra—Logarithms and logarithmic tables—Areas and volumes—Solution of triangles and trigonometrical tables—Geometrical propositions and problems—Mechanics—Strength of materials—Riveting and riveted joints—Strength and properties of steel wire—Strength and properties of wire rope—Formulas and tables for spring design—Torsional strength—Shafting—Friction—Plain, roller and ball bearings—Keys and keyways—Clutches and couplings—Friction brakes—Cams, cam design and cam milling—Spur gearing—Bevel gearing—Spiral gearing—Herringbone gearing—Worm gearing—Epicycloic gearing—Belt and rope drives—Transmission chain and chain drives—Crane chain—Dimensions of small machine details—Speeds and feeds of machine tools—Shrinkage and force fit allowances—Measuring tools and gaging methods—Change gears for spiral milling—Milling machine indexing—Jigs and fixtures—Grinding and grinding wheels—Screw thread systems and thread gages—Taps and threading dies—Milling cutters—Reamers, counterbores and twist drills—Heat-treatment of steel—Hardening, casehardening, annealing—Testing the hardness of metals—Foundry and pattern shop information—The welding of metals—Autogenous welding—Thermit welding—Machine welding—Blacksmith shop information—Die casting—Extrusion process—Soldering and brazing—Etching and etching fluids—Coloring metals—Machinery foundations—Application of motors to machine tools—Dynamo and motor troubles—Weights and measures—Metric system—Conversion tables—Specific gravity—Weights of materials—Heat—Pneumatics—Water pressure and flow of water—Pipes and piping—Lutes and cements—Patents.

MACHINERY, the leading journal in the machine-building field, the originator of the 25-cent Reference and Data Books. Published monthly. Subscription, \$2.00 yearly. Foreign subscription, \$3.00.

THE INDUSTRIAL PRESS, Publishers of MACHINERY

140-148 LAFAYETTE STREET

NEW YORK CITY, U. S. A.